

Discontinued product

WDG 543XIOM, WDG 643XIOM WDG 743XIOM, WDG 843XIOM

SSI Indicators for Use with Single-Turn or Multi-Turn SSI Encoders



WDG 543XIOM: SSI display unit only

WDG 643XIOM: SSI display unit with analogue output

WDG 743XIOM: SSI display unit with two presets and outputs

WDG 843XIOM: SSI display unit with serial interface RS323 and 485

- **Clear LED display (15 mm / 0.59" size) with adjustable brightness**
- **Master- or Slave operation with clock rates up to 1 MHz**
- **Suitable for all SSI formats from 8 to 32 bits**
- **Numerous supplementary functions like Linearization, Bit Blanking etc.**

Operating Instructions



Safety Instructions

- **This manual is an essential part of the unit and contains important hints about function, correct handling and commissioning. Non-observance can result in damage to the unit or the machine or even in injury to persons using the equipment!**
- **The unit must only be installed, connected and activated by a qualified electrician**
- **It is a must to observe all general and also all country-specific and application-specific safety standards**
- **When this unit is used with applications where failure or maloperation could cause damage to a machine or hazard to the operating staff, it is indispensable to meet effective precautions in order to avoid such consequences**
- **Regarding installation, wiring, environmental conditions, screening of cables and earthing, you must follow the general standards of industrial automation industry**
- **- Errors and omissions excepted -**

Table of Contents

1.	Terminal Assignment.....	4
1.1.	Power Supply	5
1.2.	Aux. Voltage Output	5
1.3.	Control Inputs A, B and Reset (C)	5
1.4.	Adjustable Analogue Output (WDG 643XIOM only)	6
1.5.	Optocoupler (transistor) outputs (WDG 743XIOM only)	6
1.6.	Serial RS232 / RS485 interface (WDG 843XIOM only).....	7
2.	How to Operate the Front Keys	8
2.1.	Normal display state	8
2.2.	Selection and Setting of Parameters.....	9
2.3.	Teach operation	10
2.4.	Set all parameters to “Default“	10
2.5.	Code Locking of the Keypad	10
3.	The Operator Menu	11
3.1.	Overview of Basic Parameters.....	11
3.2.	Overview of Operational Parameters	12
4.	Setup Procedure	13
4.1.	Basic Parameters.....	13
4.2.	Operational Parameters	15
4.3.	Additional Parameters for the Analogue Output (model WDG 643XIOM)	18
4.4.	Additional Parameters for Preselections and Switching Outputs (model WDG 743XIOM) ...	20
4.5.	Additional Parameters for Units with Serial Interface (model WDG 843XIOM).....	22
5.	Hints for Application	26
5.1.	Master and Slave Operation	26
5.2.	Evaluation of Encoder Bits.....	27
5.3.	Scaling of the Display.....	28
5.4.	Basic Modes of Operation	29
5.5.	Testing Functions.....	33
5.6.	Error Messages	33
6.	Special Functions	34
6.1.	Linearization	34
6.2.	Manual Input or „Teaching“ of the Interpolation Points.....	36
7.	Technical Appendix.....	38
7.1.	Dimensions	38
7.2.	Technical Specifications.....	39
7.3.	Parameter-List.....	40
7.4.	Commissioning Form	42

1. Terminal Assignment

WDG 543XIOM: Display unit only

All connections are as shown below, except for terminals 8, 9 and 10 which are unconnected

WDG 643XIOM: Display unit with analogue output

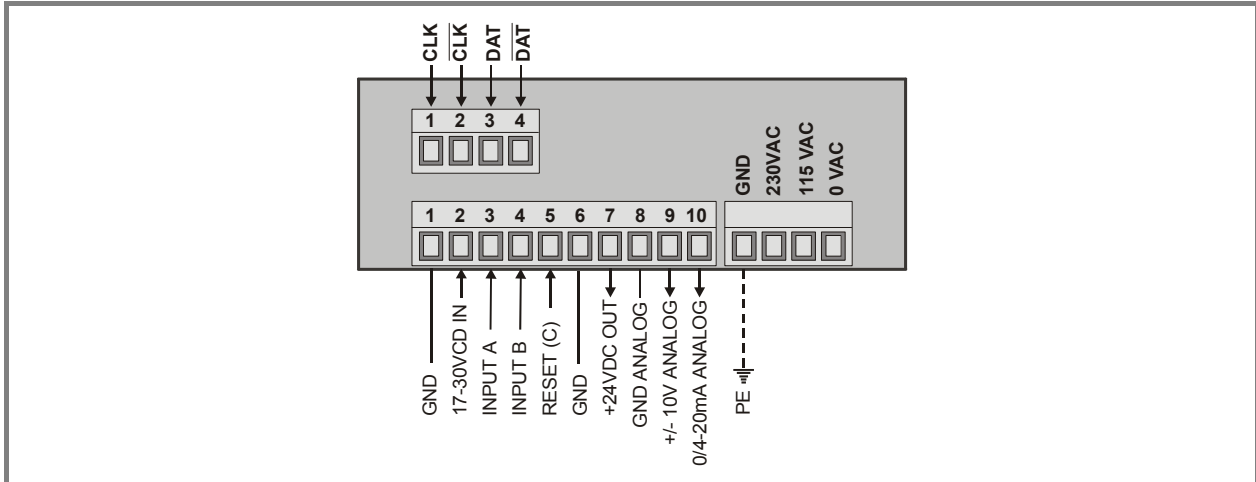

WDG 743XIOM: Display unit with two presets and outputs

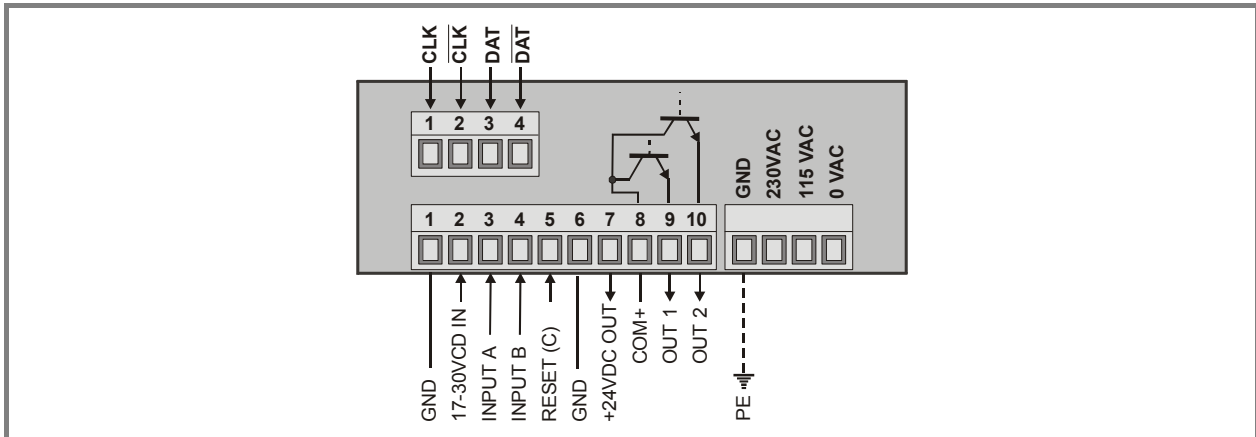

WDG 843XIOM: Display unit with serial interface

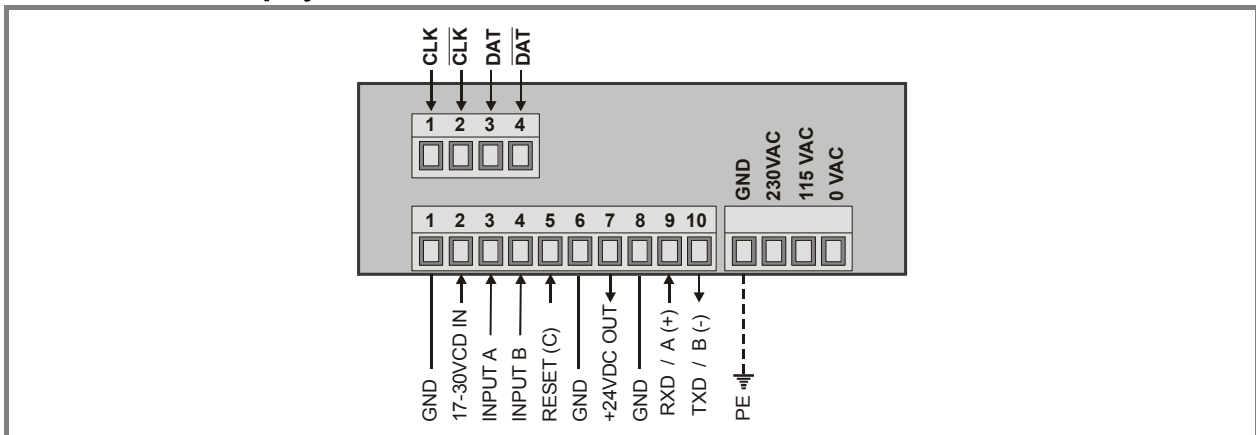

1.1. Power Supply

The unit accepts DC supply from 17 V to 30 V when using terminals 1 and 2. The consumption depends on the level of the supply voltage (typical 130mA at 30V or 190mA at 17V, plus current taken from aux. output).

For AC supply the terminals 0 VAC, 115 VAC or 230 VAC can be used.
The total AC power is 7.5 VA.

The diagrams below show a dotted line for grounding to PE.
This connection is not really necessary, neither for safety nor for EMC. However, for some applications, it may be desirable to ground the common potential of all signal lines.



When using this earthing option, please observe:

- All terminals and potentials marked “GND“ will be earthed.
- Please avoid multiple earthing, i.e. when you use a DC power supply where the Minus is already connected to earth etc.

1.2. Aux. Voltage Output

Terminal 7 provides an auxiliary output of 24 VDC / 120 mA max. for supply of sensors and encoders.

1.3. Control Inputs A, B and Reset (C)

Standard units use only input “C” as a Reset input and the other inputs are out of function.

In the basic setup menu, the inputs can be configured to PNP (signal must switch to +) or NPN (signal must switch to -). This configuration is valid for all three inputs at a time.
The factory setting is always PNP.



- **Where NPN setting is used, please observe:**
Open NPN inputs will always represent a logical HIGH state
Consequently, Input C has to be connected to GND externally to allow normal operation.
If unconnected, the unit would be kept in a continuous Reset state.
With models WDG 843XIOM, also Input A must be tied to GND, and opening this connection will generate a rising edge to start a serial transmission
- **Where your use 2-wire NAMUR type sensors, please select NPN, connect the negative wire of the sensor to GND and the positive wire to the corresponding input.**

Typical input circuit of control input

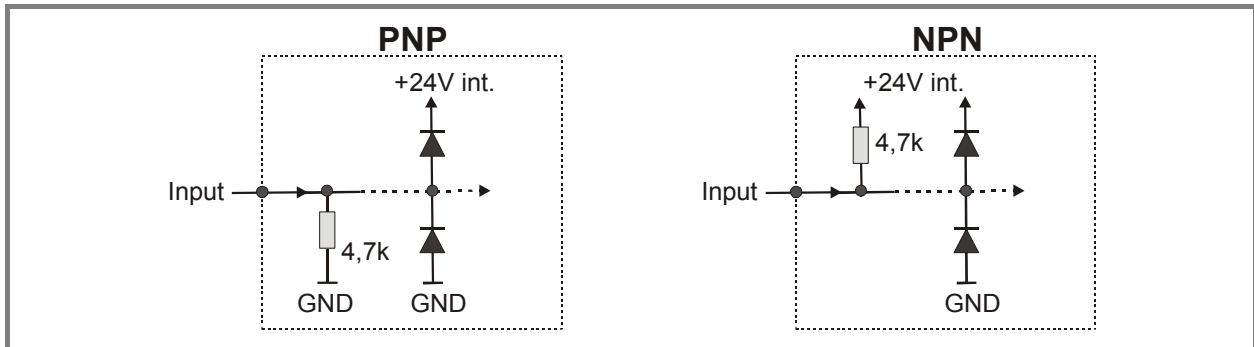

The minimum pulse duration on the Reset input (C) must be 5 msec.

1.4. Adjustable Analogue Output (WDG 643XIOM only)

A voltage output is available, operating in a range of 0 ... +10 V or -10 V ... +10 V according to setting. At the same time, a current output 0/4 - 20 mA is available. Both outputs refer to the GND potential and the polarity changes with the sign in the display. The outputs are proportional to the display value and provide a 14 bits resolution.

The maximum current on the voltage output is 2 mA, and the load on the current output can vary between 0 and max. 300 ohms.

The response time of the analogue output to changes of the encoder position is approx. 7 msec.

1.5. Optocoupler (transistor) outputs (WDG 743XIOM only)

The outputs provide programmable switching characteristics and are potential-free. Please connect terminal 8 (COM+) to the positive potential of the voltage you like to switch (range 5V....35V). You must not exceed the maximum output current of 150 mA. Where you switch inductive loads, please provide filtering of the coil by means of an external diode.

The optocoupler outputs provide a response time of approx. 5 msec with resistive load.

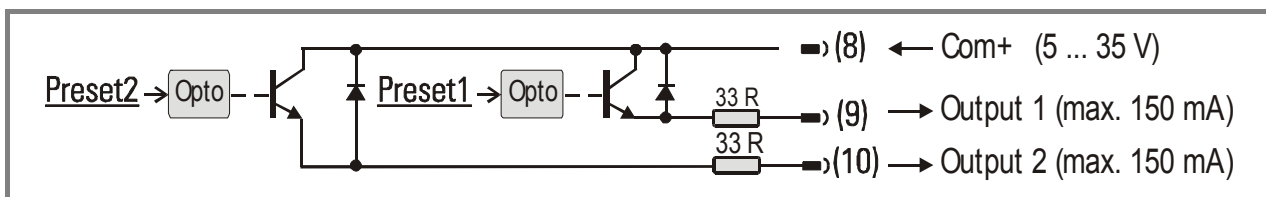

1.6. Serial RS232 / RS485 interface (WDG 843XIOM only)

Ex factory the unit is set to RS232 communication. This setting can be changed to RS485 (2-wire) by means of an internal DIL switch. To access the DIL switch, you must remove the screw terminal connectors and the backplane. Then pull the board to the rear to remove the PCB from the housing.

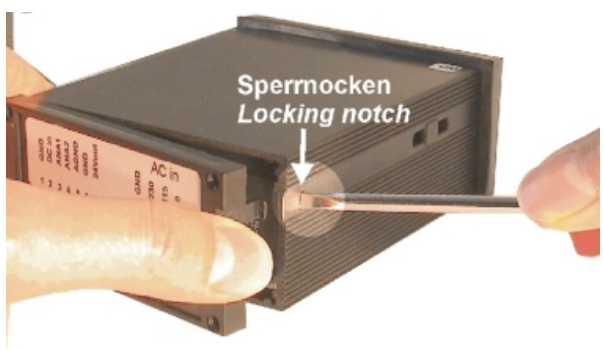
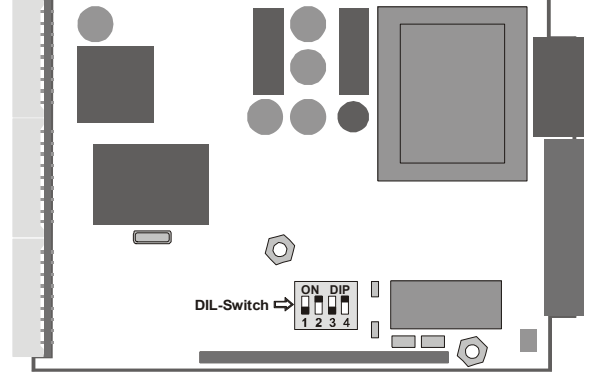
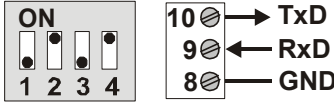
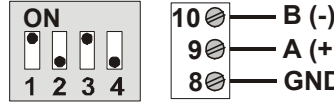
 <p>Removal of the back plane</p>	 <p>Location of the DIL switch</p>
<p>RS232:</p> 	<p>RS485:</p> 



- Never set DIL switch positions 1 and 2 or DIL switch positions 3 and 4 to "ON" at the same time!**
- After setting the switch, shift the print carefully back to the housing and avoid damage of the front pins for connection to the front keypad plate.**

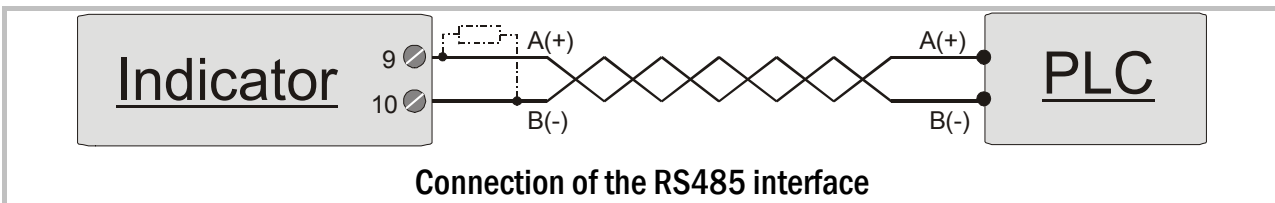
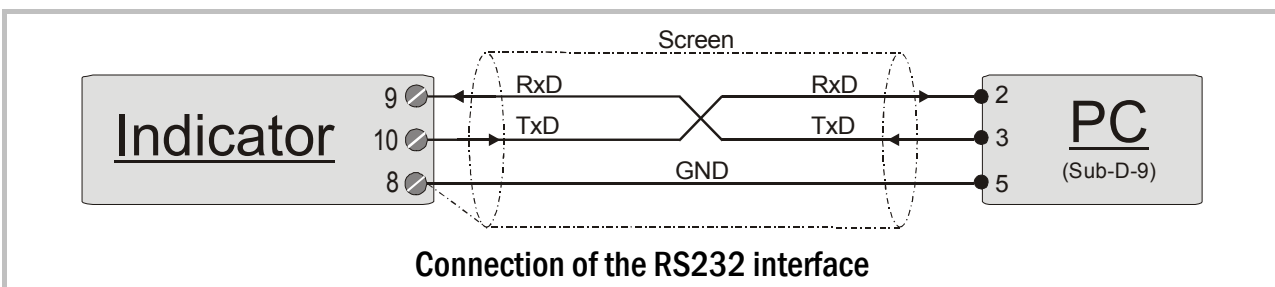

2. How to Operate the Front Keys

For setup and other operations the unit uses three front keys which subsequently will be denominated as follows:

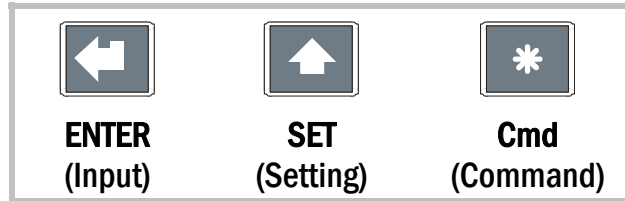

The functions of the keys are depending on the actual operating state of the unit.

The following three operating states apply:

- **Normal display state**
- **Setup state**
 - a.) Basic setup
 - b.) Operational parameter setup
- **Teach operation**

2.1. Normal display state



You can only change over to other operation states while the unit is in the normal display state.

Change over to	Key operation
Basic setup	Keep ENTER and SET down simultaneously for 3 seconds
Operational parameter setup	Keep ENTER down for 3 seconds.
Teach operation	Keep Cmd down for 3 seconds

The Cmd key is only used to execute the Teach procedure with linearization. For more details please refer to sections 6.1 and 6.2.

2.2. Selection and Setting of Parameters

2.2.1. How to select a parameter

The **ENTER** key will scroll through the menu. The **SET** key allows to select the corresponding item and to change the setting or the numeric value. After this, the selection can be stored by **ENTER** again, which automatically changes over to the next menu item.

2.2.2. How to change parameter settings

With numerical entries, at first the lowest digit will blink. When keeping the **SET** key continuously down, the highlighted digit will scroll in a continuous loop from 0 ... 9 , 0 ... 9. After releasing the **SET** key, the actual value will remain and the next digit will be highlighted (blink). This procedure allows setting of all digits to the desired values. After the most significant digit has been set, the low order digit will blink again and you can do corrections if necessary.

With signed parameters, the high order digit will scroll from "0" to "9" (positive) followed by "- " and "-1" (negative)

2.2.3. How to store settings

To store the actual setting, press the **ENTER** key, which will also automatically scroll forward the menu.

At any time the unit changes from programming mode to normal display operation, when you keep the **ENTER** key down again for at least 3 seconds.



2.2.4. Time-out function

A "time-out" function will automatically conclude every menu level, when for a break period of 10 seconds no key has been touched. In this case, any changes which have not been confirmed by **ENTER** yet would remain unconsidered.

2.3. Teach operation



The Time-out function will be switched off during all Teach operations

Key	Function
	ENTER will conclude or abort any Teach operation in progress
	SET function is fully similar to normal set-up operation
	Cmd will store the display value to the register and will change over to the next interpolation point.

For details of the Teach procedure see section 6.2.

2.4. Set all parameters to “Default“

At any time you can return all settings to the factory default values.

The factory default settings are shown in the parameter listings in section 6.



When you decide to set all parameters to „default“, please be aware that all previous settings will be lost and you will need to do the whole set-up procedure once more

To execute the „Default“ setting function:

- Power the unit down.
- Press the ENTER key.
- Power the unit up again while the ENTER key is kept down

2.5. Code Locking of the Keypad

When the code locking of the keypad has been switched on, any key access first results in display of



To access the menu you must press the key sequence



within 10 seconds, otherwise the unit will automatically return to the normal display mode.

3. The Operator Menu

The menu provides one section with “Basic Parameters” and another section with “Operational Parameters”. On the display you will only find those parameters which have been enabled by the basic settings. E.g. when the Linearisation Functions have been disabled in the basic set-up, the associated linearization parameters will also not appear in the parameter menu.

All parameters, as good as possible, are designated by text fragments. Even though the possibilities of forming texts are very limited with a 7-segment display, this method has proved to be most suitable for simplification of the programming procedure.

The subsequent table shows the general structure of the whole menu only. Detailed descriptions of all parameters will follow in section 4.

3.1. Overview of Basic Parameters

WDG 543XIOM	I WDG 643XIOM	WDG 743XIOM	WDG 843XIOM
SSI_Mode	SSI_Mode	SSI_Mode	SSI_Mode
SSI_Bits	SSI_Bits	SSI_Bits	SSI_Bits
SSI_Format	SSI_Format	SSI_Format	SSI_Format
SSI_Baud Rate	SSI_Baud Rate	SSI_Baud Rate	SSI_Baud Rate
SSI_Test	SSI_Test	SSI_Test	SSI_Test
Characteristics	Characteristics	Characteristics	Characteristics
Brightness	Brightness	Brightness	Brightness
Code Locking	Code Locking	Code Locking	Code Locking
Linearization Mode	Linearization Mode	Linearization Mode	Linearization Mode
	Analogue Characteristics	Preselection_Mode 1	Ser_Unit_Nr
	Analogue Offset	Preselection_Mode 2	Ser_Format
	Analogue Gain	Hysteresis 1	Ser_Baudrate
		Hysteresis 2	

3.2. Overview of Operational Parameters

WDG 543XIOM	WDG 643XIOM	WDG 743XIOM	WDG 843XIOM
		Preselection 1 Preselection 2	
M-Factor	M-Factor	M-Factor	M-Factor
D-Factor	D-Factor	D-Factor	D-Factor
P-Factor	P-Factor	P-Factor	P-Factor
Decimal point	Decimal point	Decimal point	Decimal point
Display	Display	Display	Display
Hi_Bit (MSB)	Hi_Bit (MSB)	Hi_Bit (MSB)	Hi_Bit (MSB)
Lo_Bit (LSB)	Lo_Bit (LSB)	Lo_Bit (LSB)	Lo_Bit (LSB)
Direction	Direction	Direction	Direction
Error	Error	Error	Error
Error_Polarity	Error_Polarity	Error_Polarity	Error_Polarity
Round Loop	Round Loop	Round Loop	Round Loop
Time	Time	Time	Time
Reset	Reset	Reset	Reset
Zero Position	Zero Position	Zero Position	Zero Position
	Analogue Begin Analogue End		Ser_Timer Ser_Mode Ser_Value
P01_X *)	P01_X *)	P01_X *)	P01_X *)
P01_Y*)	P01_Y*)	P01_Y*)	P01_Y*)
→	→	→	→
P16_X *)	P16_X *)	P16_X *)	P16_X *)
P16_Y *)	P16_Y *)	P16_Y *)	P16_Y *)

*) appears only when Linearization has been enabled in the Basic Menu

4. Setup Procedure

For better understanding the following sections 4.1 and 4.2 explain settings for the display only. Model-specific settings for Analogue Output, Preselections and Serial Link will be explained separately, later.

4.1. Basic Parameters

The subsequent settings are of unique nature and must only be made upon the very first setup. The basic setup selects the desired operation mode of the unit, the input characteristics PNP/NPN and the desired brightness of the LED display.

Menu		Setting Range	Default
Mode	SSI-Mode Setting of Master Mode or Slave Mode For details see section 5.1	Master Slave	Master
Bits	SSI-Bits Bit length of the SSI string For more details see section 5.2	08 32	25
Format	SSI-Format: Setting of the SSI code (Binary or Gray)	bin GRAY	bin
Baud	SSI-Baud Rate	0.1 ... 1000.9 kHz	100.0 kHz
Test	SSI Test SSI Self test functions (see 5.5.)	Call etc.	
Char	Characteristics Switching characteristics of the Reset input NPN: switch to "-" PNP: switch to "+"	NPN PNP	PNP
Bright	Brightness Brightness of the 7-segment LED display	20%, 40%, 60% 80% and 100%	100%

Menu		Setting Range	Default
Code	Code Locking Interlock of keypad access (see 2.5) no: Keypad accessible at any time All: Keypad interlock for all functions P-Free: Keypad interlock except for Preselection Settings Pres 1 und Pres 2 (model WDG 743XIOM)	<input type="text" value="no"/> <input type="text" value="ALL"/> <input type="text" value="P_FREE"/>	<input type="text" value="no"/>
LinER	Linearization Mode For details please see 6.1 und 6.2. no: Linearization is switched OFF *) 1-qua: Linearization settings for the positive range only (negative values will appear as a mirror). 4-qua: Linearization over the full numeric range	<input type="text" value="no"/> <input type="text" value="1-QUA"/> <input type="text" value="4-QUA"/>	<input type="text" value="no"/>

*) The menu will not display any further linearization parameters

4.2. Operational Parameters

Menu		Setting Range	Default
M-Factor *) M-Factor *): Multiplying factor for the SSI value (after consideration of possible bit blanking)	M-Factor *) Multiplying factor for the SSI value (after consideration of possible bit blanking)	-9.999 ... 9.999	1.000
D-Factor *) D-Factor *): Dividing factor for the SSI value (after consideration of possible bit blanking)	D-Factor *) Dividing factor for the SSI value (after consideration of possible bit blanking)	0.001 ... 9.999	1.000
P-Factor *) P-Factor *): This signed value will be added to the SSI result (after consideration of possible bit blanking)	P-Factor *) This signed value will be added to the SSI result (after consideration of possible bit blanking)	-199999 ... 999999	0
Decimal Point Setting according to the decimal formats shown in the display	Decimal Point Setting according to the decimal formats shown in the display	000000 00000.0 ... 0.00000	00000.0
Display: Display mode of the unit norm: regular scaling of the display 359.59: Angular display format 359° 59' with use of the Round Loop Function	Display: Display mode of the unit norm: regular scaling of the display 359.59: Angular display format 359° 59' with use of the Round Loop Function	norm 359.59	norm
Hi Bit **): Bit Blanking Function: Defines the highest bit for evaluation. To evaluate all encoder bits this parameter has to be set to the total number of bits according to setting	Hi Bit **): Bit Blanking Function: Defines the highest bit for evaluation. To evaluate all encoder bits this parameter has to be set to the total number of bits according to setting	1 ... 32	25
Lo Bit **): Bit Blanking Function: Defines the lowest bit for evaluation. To evaluate all encoder bits this parameter has to be set to "01"	Lo Bit **): Bit Blanking Function: Defines the lowest bit for evaluation. To evaluate all encoder bits this parameter has to be set to "01"	1 ... 31	1

*) Scaling details are explained under 5.3

**) For more details about Bit Blanking see 5.2

Menu		Setting Range	Default
<code>dir</code>	Direction Parameter to negate the SSI value, resulting in reversal of the direction of the encoder count. riGht: ascending values with forward motion LEfT: decreasing values with forward motion	riGht LEfT	riGht
<code>Error</code>	Error: (please refer to 5.6) Defines the control of presence of an encoder and the location of the Error Bit in case of error. 00: No error bit available Control of presence of an encoder is off 01: No error bit available Control of presence of an encoder is on >01: Location of the error bit Control of presence of an encoder is on	0 ... 32	0
<code>ErrorP</code>	Error-Polarity *): Defines the polarity of the Error Bit in case of error. 0: Error Bit is Low in case of error 1: Error bit is High in case of error	0 1	0
	When an error occurs, „ Err-b “ appears on the display. The same function can also be used to monitor the Power Failure Bit of an encoder (mostly called „PFB“).		
<code>r-Loop</code>	Round Loop Defines the number of encoder steps per revolution with use of the Round Loop Function (see 5.4.2). 0: Normal display of the encoder data, no Round Loop Function >0: Number of steps per Round Loop Cycle	0 ... 999999	0
<code>t in tE</code>	Time Sets the update cycle of the display (and of the analogue output or the switching outputs where applicable). The fastest possible update time is 3 msec. respectively one telegram length including 4 pause clocks. With Slave operation the next update will occur when the unit synchronizes again to the Master pause following to the expiration of the update time.	0.000 ... 1.009 sec	0.01 sec

Menu		Setting Range	Default
FE rES	Reset A Reset command is available to store the actual SSI position to register „Zero Position“. As a result, the display value will become zero at the actual encoder position, and all further operation will refer to this new datum point. The zero position remains memorized also after power-down. no: Reset function disabled Front: Reset function by the front SET key E_tErn: Reset function by the remote Reset input FR u E: Reset via key and remote input	<input type="text" value="no"/> <input type="text" value="Front"/> <input type="text" value="E_tErn"/> <input type="text" value="FR u E"/>	<input type="text" value="no"/>
0-Pos	Zero Position: *) Defines the zero position of the display. When you set this parameter to e.g. "1024", the unit will display zero when the encoder position is 1024. Zero Position can be set directly via keypad or by means of an external Reset command.	-199999 ... 999999	0
P01_X **)	Linearization Point 1_X X value of the first interpolation point.	-199999 ... 999999	999999
P01_Y	Linearization Point 1_Y Y value of the first interpolation point.	-199999 ... 999999	999999
	...		
P16_X	Linearization Point 16_X X value of the 16. interpolation point.	-199999 ... 999999	999999
P16_Y	Linearization Point 16_Y Y value of the 16. interpolation point.	-199999 ... 999999	999999

*) Please observe that Parameter P_Fac will cause an additional displacement of the zero position

***) Parameters P01_X to P16_Y appear only when the linearization has been enabled in the basic menu

4.3. Additional Parameters for the Analogue Output (model WDG 643XIOM)

The following additional settings for the analogue output appear in the Basic Menu:

Menu		Setting Range	Default
A-CHAR	Analogue Characteristics You can set the following output options: +/- 10 V (bipolar), 0 - 10 V (positive only), 4 - 20 mA 0 - 20 mA. With setting +/- 10 Volts the polarity of the output voltage will follow the sign in the display	<div style="border: 1px solid black; padding: 2px; display: inline-block;">- 10_ 10</div> <div style="border: 1px solid black; padding: 2px; display: inline-block;">0_ 10</div> <div style="border: 1px solid black; padding: 2px; display: inline-block;">4_ 20</div> <div style="border: 1px solid black; padding: 2px; display: inline-block;">0_ 20</div>	- 10_ 10
OFFSET	Analogue Offset: Set this parameter to 0 when you expect your analogue signal to start with 0 V (or 0 mA / 4 mA respectively). Where another zero definition is desired it can be set by this parameter. Setting of e.g. 5.000 will already produce 5 volts with the output in zero state.	-9,999..+9,999	0,000
GA in	Analogue Gain: Parameter to set the analogue output swing. Setting 10.00 will allow full swing of 10 V or 20 mA, setting 8.00 will reduce the swing to 8 V or 16 mA.	00,00..99,99	10,00

The following Operational Parameters provide scaling of the analogue output:

Menu		Setting Range	Default
AnAbEG	Analogue-Begin Start value of the analogue conversion range	- 199999...999999	0
AnAEnd	Analogue-End End value of the analogue conversion range	- 199999...999999	100000

By means of these two parameters any window of the whole display range can be mapped onto the analogue output.

The subsequent example shows how to convert the display range from 1400 to 2000 into an analogue signal of 2 - 10 volts.

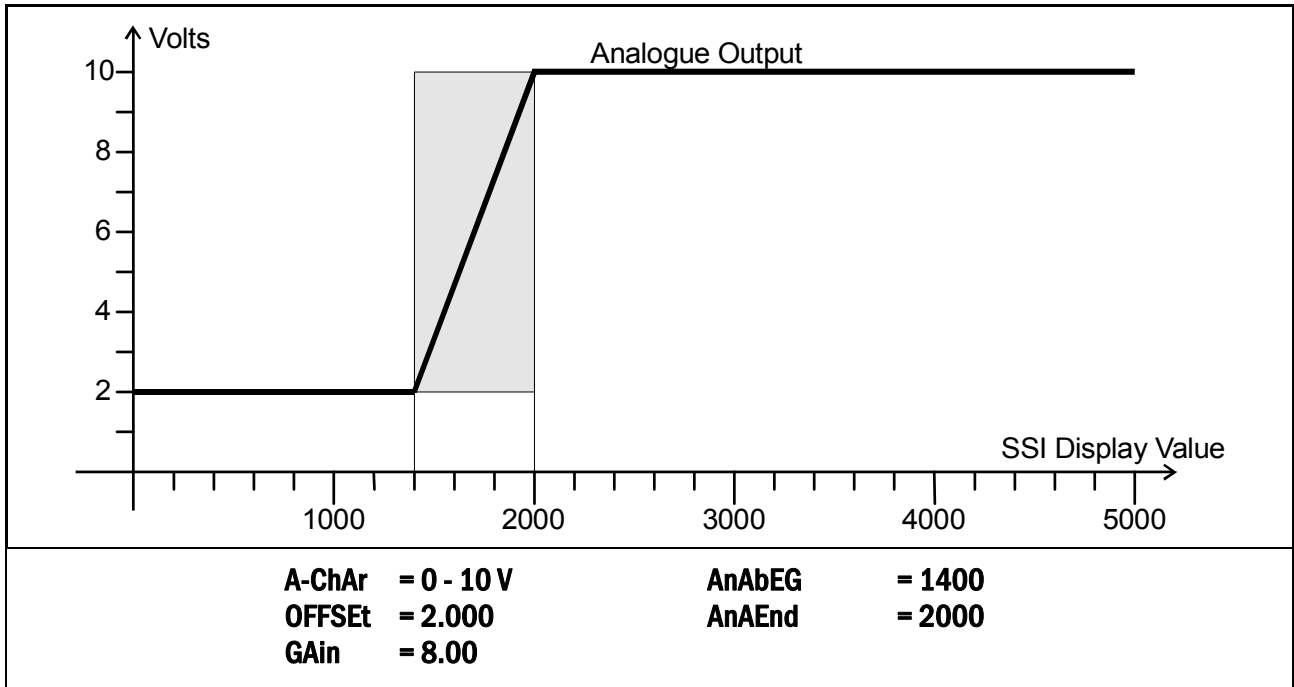

All settings refer to the scaled values shown in the display of the unit, and not to the original SSI encoder data

4.4. Additional Parameters for Preselections and Switching Outputs (model WDG 743XIOM)

The following additional settings for the Preselections appear in the Basic Menu:

Menu		Default
CHAR 1	Switching Characteristics of Output 1	__r GE
	__r GE Greater/Equal. Output to switch statically ON when <u>Display Value</u> \geq <u>Preselection1</u>	
	__r LE Lower/Equal. Output to switch statically ON when <u>Display Value</u> \leq <u>Preselection1</u>	
	n GE Greater/Equal. Output to switch dynamically ON when <u>Display Value</u> \geq <u>Preselection1</u> (timed output pulse) *)	
	n LE Lower/Equal. Output to switch dynamically ON when <u>Display Value</u> \leq <u>Preselection1</u> (timed output pulse) *)	
CHAR 2	Switching Characteristics of Output 2	__r GE
	__r GE See above, but Preselection2	
	__r LE See above, but Preselection2	
	n GE See above, but Preselection2	
	n LE See above, but Preselection2	
	_J- 1-2 Output to switch statically ON when <u>Display Value</u> \geq <u>Preselection1</u> - <u>Preselection2</u> **)	
	n 1-2 Output to switch dynamically ON when <u>Display Value</u> \geq <u>Preselection1</u> - <u>Preselection2</u> **)	
HYSt 1	Hysteresis 1 Adjustable hysteresis for output 1 Setting range 0 ... 99999 display units	0
HYSt 2	Hysteresis 2 Adjustable hysteresis for output 2 Setting range 0 ... 99999 display units	0

*) Timed output pulses have a fixed duration of 500 msec (factory adjustable only)

**) Trailing Preset to generate an anticipation signal with a fixed distance to the main signal

The following Operational Parameters provide setting of the switching thresholds:

Menu		Setting Range	Default
PrES_1	Preselection 1:	-199999.. 999999	10000
PrES_2	Preselection 2:	-199999.. 999999	5000

The direction of the Hysteresis effect depends on the setting of the switching characteristics. With the settings „GE“ or „LE“ the following switch points will result:

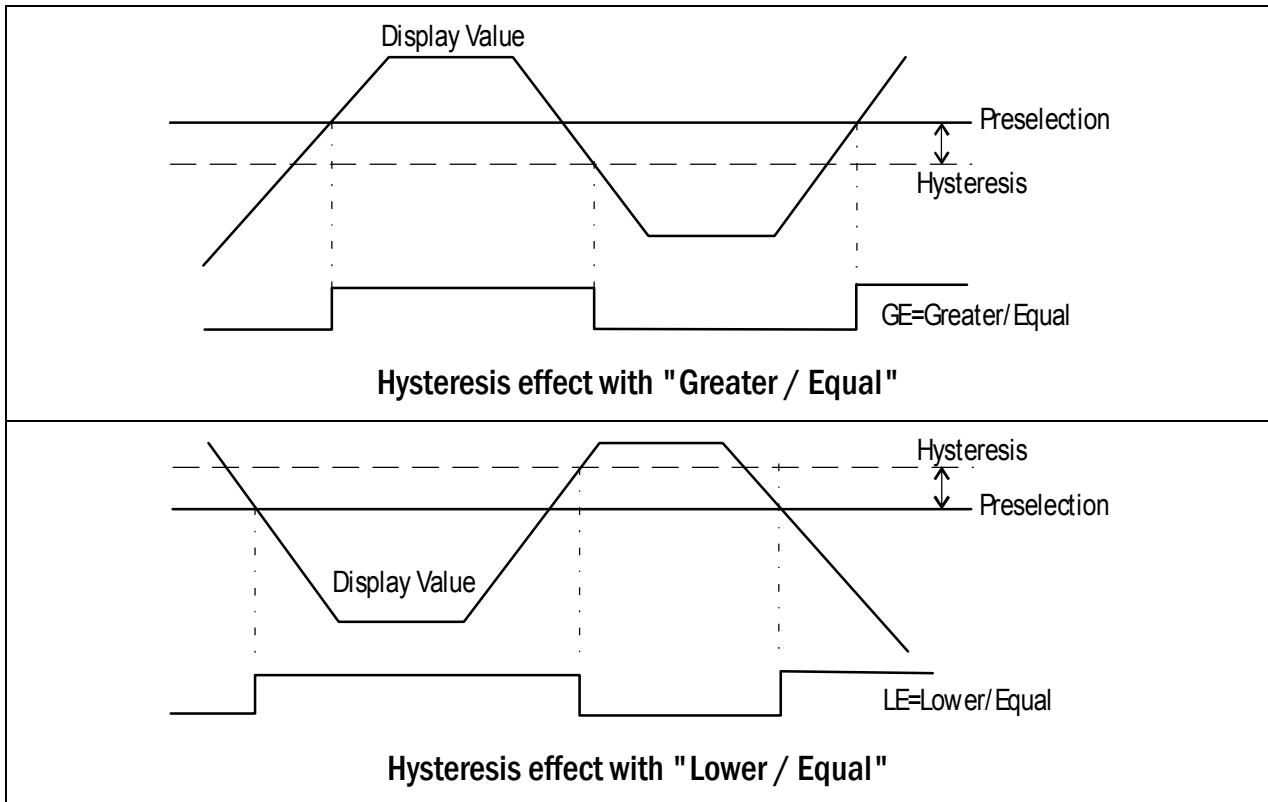

It is possible to check up on the actual switching state of the outputs at any time.

For this, just tap on the **ENTER** key shortly.

The display will then show for the next two seconds one of the following information:

Display	Meaning
1.2oFF	Both outputs are actually OFF
1.2oN	Both outputs are actually ON
1 on	Output 1 is ON Output 2 is OFF
2on	Output 1 is OFF Output 2 is ON

4.5. Additional Parameters for Units with Serial Interface (model WDG 843XIOM)

The following additional settings for serial communications appear in the Basic Menu:

Menu	Setting Range	Default
S-Unit Unit Number You can assign any unit number between 11 and 99. The address must however <u>not</u> contain a "0" because such numbers are reserved for collective addressing of several units.	0..99	11
S-Form Serial Data Format The first character indicates the number of data bits. The second character specifies the Parity Bit „Even“, "Odd" or no Parity Bit. The third character indicates the number of Stop Bits.	7 E 1 7 E 2 7 0 1 7 0 2 7 no 1 7 no 2 8 E 1 8 0 1 8 no 1 8 no 2	7 E 1
S-bAUD Baud Rate The following Baud Rates can be set for communication:	9600 4800 2400 1200 600 19200 38400	9600

The following Operational Parameters provide configuration of the serial interface:

Menu		Setting Range	Default																
<div style="border: 1px solid black; display: inline-block; padding: 2px;">S-t int</div> Serial Timer: Setting 0,000 allows manual activation of a serial data transmission at any time. All other settings specify the cycle time for automatic transmission, when the interface is set to "Printer Mode" Between two transmission cycles the unit will allow a pause depending on the baud rate. The minimum cycle times for timer transmissions are shown in the table. <table border="1" style="margin-left: 40px; margin-top: 10px;"> <thead> <tr> <th>Baud Rate</th> <th>Minimum Cycle Time [ms]</th> </tr> </thead> <tbody> <tr><td>600</td><td>384</td></tr> <tr><td>1200</td><td>192</td></tr> <tr><td>2400</td><td>96</td></tr> <tr><td>4800</td><td>48</td></tr> <tr><td>9600</td><td>24</td></tr> <tr><td>19200</td><td>12</td></tr> <tr><td>38400</td><td>6</td></tr> </tbody> </table>	Baud Rate	Minimum Cycle Time [ms]	600	384	1200	192	2400	96	4800	48	9600	24	19200	12	38400	6		0,000 0,010 sec ... 9.999 sec	0,100 sec
Baud Rate	Minimum Cycle Time [ms]																		
600	384																		
1200	192																		
2400	96																		
4800	48																		
9600	24																		
19200	12																		
38400	6																		
<div style="border: 1px solid black; display: inline-block; padding: 2px;">S-mode</div> Serial Mode: PC: Operation according to communication profile (see 4.5.1) Print1: Transmission of string type 1 (see 4.5.2) Print2: Transmission of string type 2 (see 4.5.2)		<div style="border: 1px solid black; display: inline-block; padding: 2px;">PC</div> <div style="border: 1px solid black; display: inline-block; padding: 2px;">Print1</div> <div style="border: 1px solid black; display: inline-block; padding: 2px;">Print2</div>	<div style="border: 1px solid black; display: inline-block; padding: 2px;">PC</div>																
<div style="border: 1px solid black; display: inline-block; padding: 2px;">S-Code</div> Serial Register-Code: Specifies the register code of the data to be transmitted. The most important register codes are: <table border="1" style="margin-left: 40px; margin-top: 10px;"> <thead> <tr> <th>Register</th> <th>S-Code</th> <th>ASCII</th> <th>Description</th> </tr> </thead> <tbody> <tr> <td>Original SSI Value</td> <td>111</td> <td>; 1</td> <td>Direct encoder data</td> </tr> <tr> <td>SSI Value</td> <td>113</td> <td>; 3</td> <td>Encoder data after Bit Blanking</td> </tr> <tr> <td>Display value</td> <td>101</td> <td>: 1</td> <td>Value with full scaling as it appears in the display</td> </tr> </tbody> </table>	Register	S-Code	ASCII	Description	Original SSI Value	111	; 1	Direct encoder data	SSI Value	113	; 3	Encoder data after Bit Blanking	Display value	101	: 1	Value with full scaling as it appears in the display		100 ... 120	101
Register	S-Code	ASCII	Description																
Original SSI Value	111	; 1	Direct encoder data																
SSI Value	113	; 3	Encoder data after Bit Blanking																
Display value	101	: 1	Value with full scaling as it appears in the display																

4.5.1. PC-Mode

Communication with PC - Mode allows free readout of all parameters and registers of the unit. The subsequent example shows the details of communication for serial readout of the actual display value.

The general string to initiate a request has the following format:

EOT	AD1	AD2	C1	C2	ENQ
EOT = Control Character (Hex 04) AD1 = Unit Address, High Byte AD2 = Unit Address, Low Byte C1 = Register Code, High Byte C2 = Register Code, Low Byte ENQ = Control Character (Hex 05)					

Example:

Request string for readout of the actual display data from a unit with serial address No. 11:

ASCII-Code:	EOT	1	1	:	1	ENQ
Hex:	04	31	31	3A	31	05
Binary:	0000 0100	0011 0001	0011 0001	0011 1010	0011 0001	0000 0101

With a correct request the unit will respond with the adjoining response string. Leading zeros will be suppressed. BCC provides a „Block Check Character“, formed by Exclusive-OR of all characters from C1 through ETX.

STX	C1	C2	xxxxxxx	ETX	BCC
STX = Control Character (Hex 02) C1 = Register Code, High Byte C2 = Register Code, Low Byte xxxxx = Data (display value) ETX = Control Character (Hex 03) BCC = Block Check Character					

With inaccurate request strings the unit would only respond "STX C1 C2 EOT" or just "NAK".

4.5.2. Printer Mode

The Printer Mode allows cyclic or manual activation of transmissions of the specified register data. The corresponding register can be specified by means of parameter „S-Code“.

Another parameter named „S-mod“ allows selection between two different string types:

„S-mod“	Transmission String Type									
„Print1“	Space	Sign	Data						Line feed	Carriage return
		+/-	X	X	X	X	X	X	LF	CR
„Print2“	Sign	Data						Carriage return		
	+/-	X	X	X	X	X	X	CR		

The mode of activation of serial transmissions can be determined as follows:

Cyclic (timed) transmissions:	Set the Serial Timer to any value ≥ 0.010 sec. Select the desired string type by parameter "S-mod" After exit from the menu the transmissions will start automatically
Manual activation of transmissions	Set the Serial Timer to 0.000. Select the desired string type by parameter "S-mod" After exit from the menu a transmission can be activated at any time - - by shortly pressing the ENTER key or - by a rising edge to Control Input A

5. Hints for Application

5.1. Master and Slave Operation

Set register “Mode” to position “Master” when the unit should generate the clock signal for the encoder. In this case the clock terminals (CLK) are configured as clock outputs.

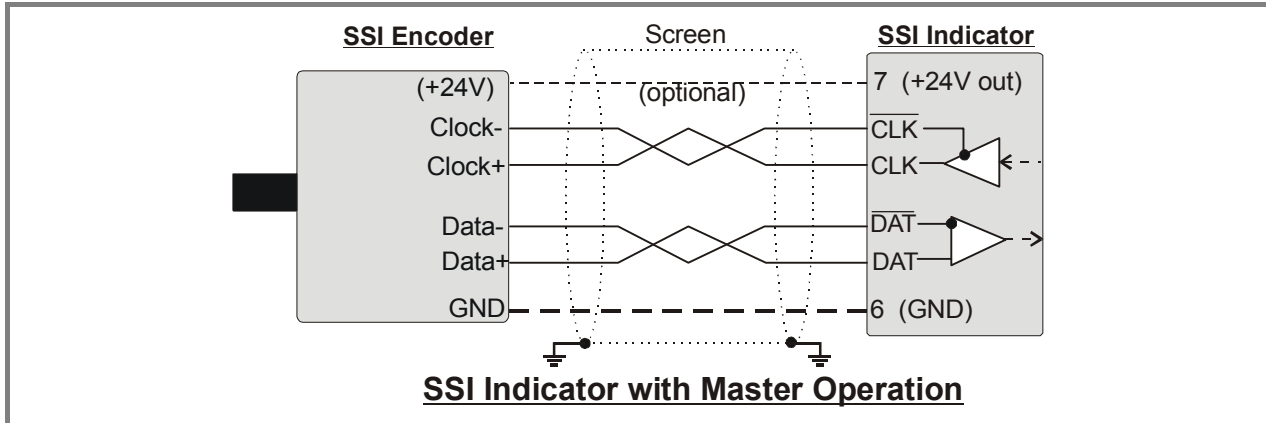

When your encoder receives already its clock from another device and the unit should only “listen” to the communication, then set register “Mode” to “Slave”. In this case, both clock terminals (CLK) are configured as inputs.

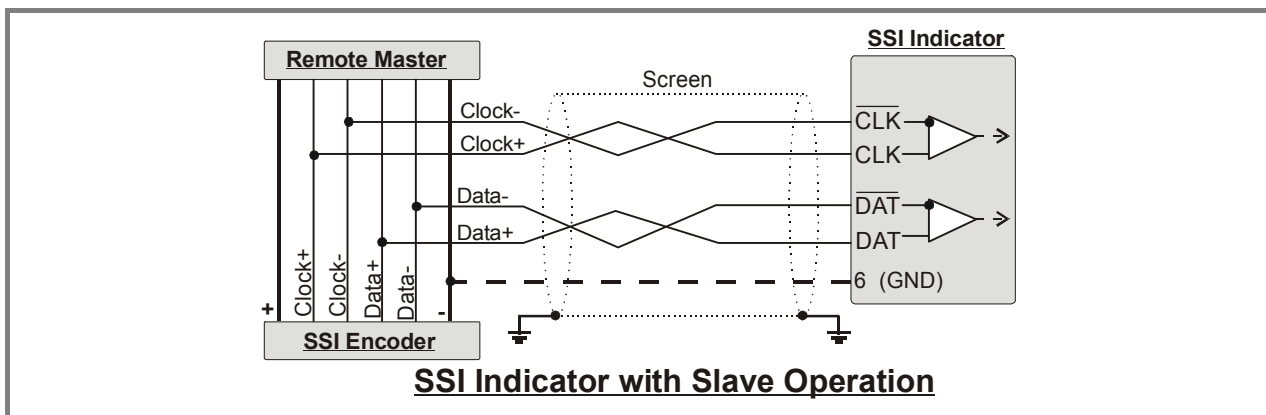

Set registers “Bits”, “Format” and “Baud” according to the encoder you use.

You are free to set any baud rate in a range from 0.1 kHz to 1000.0 kHz. For technical reasons however, in the upper frequency range, the unit itself in master mode can only generate one of the following Baud rates accurately:

1000,0 kHz	888,0 kHz	800,0 kHz	727,0 kHz	666,0 kHz
615,0 kHz	571,0 kHz	533,0 kHz	500,0 kHz	470,0 kHz
444,0 kHz	421,0 kHz	400,0 kHz	380,0 kHz	363,0 kHz
347,0 kHz	333,0 kHz	320,0 kHz	307,0 kHz	296,0 kHz
285,0 kHz	275,0 kHz	266,0 kHz	258,0 kHz	250,0 kHz

With Master operation, therefore other settings will result in generation of the next upper or lower value according to above list. With all settings <250.0 kHz the error between set rate and generated rate becomes negligible.

It is mandatory to set the Baud rate also with Slave operation. In this case, however, the setting serves only to determine the pause time for correct synchronization (pause is detected after 4 clock cycles). The unit automatically synchronizes with every remote clock signal within the specified Baud rate range.

5.2. Evaluation of Encoder Bits

This chapter explains the correlation between the Basic Parameter „BitS“ and the Operational Parameters „Hi bit“ and „Lo bit“. The example below uses an encoder with 16 bits.



- Unused Bits may be blanked out according to individual need
- Whenever the number of bits (clock cycles) requested from the SSI Master is higher than the real number of encoder bits, all excessive Bits must be blanked by corresponding setting of parameters „Hi_bit“ and „Lo_bit“.

Basic Settings:

In general, parameter „BitS“ will always be set according to the real resolution of the encoder (i.e. "BitS" = 16 with a 16 bit encoder). In this normal case the SSI telegram will not contain any excessive bits.

With some applications (e.g. with Slave operation) it may however happen that the Master transmits more clock cycles than the number of encoder bits (e.g. 21 clocks with a 16 bit encoder). In such a case the master would always request 21 bits from the encoder, where the encoder itself responds with 16 usable bits only, followed by 5 waste bits. These 5 excessive bits must be blanked.

All standard SSI telegrams start with the most significant bit (MSB) and close with the least significant bit (LSB). Unusable waste bits (X) will follow at the tail end. To blank these bits out, in our example we would have to set „Hi bit“ to 21 and „Lo bit“ to 6 for proper evaluation of the encoder information.

	Hi Bit ↓															Lo Bit ↓					
Requested Bits (Clocks)	21	20	19	18	17	16	15	14	13	12	11	10	9	8	7	6	5	4	3	2	1
Usable Bits (encoder)	16	15	14	13	12	11	10	9	8	7	6	5	4	3	2	1	X	X	X	X	X

5.3. Scaling of the Display

Under consideration of the scaling parameters which have been described previously, the final display value of the unit results from

$$\text{DISPLAY} = \{ [\text{Encoder SSI Data}] - [\text{0-Position}] \} \times \frac{\text{M-Factor}}{\text{D-Factor}} \quad +/- \quad \text{P-Factor}$$



- Encoder SSI data are always positive only. Where also negative values should be indicated, this can be achieved by corresponding setting of the parameters „0-Position“ or „P-Factor“
- The LED display provides 6 decades. For this reason all parameter settings (including 0-Position) are also limited to a maximum range of 6 decades. SSI encoders with a resolution of more than 19 bits will however generate SSI data with more than 6 decades. In such a case it can become difficult to set the 0-Position and the other scaling parameters while the mechanical encoder position is in the overflow zone (the unit would insistently display "overflow").

To avoid this kind of problem with encoders of more than 19 bits, we recommend to use the Bit Blanking Function and evaluate 19 bits only

- Where later you intend to use the "Round Loop" function, it is mandatory to blank all unused bits.
- Remote Reset/Set commands via keyboard or external input will overwrite the current value of parameter „0-Position“ by the actual SSI position of the encoder. Therefore, in the formula above, the content between the brackets { } will become zero and the unit will display the same value as set to parameter „P-Factor“. This scaling is also automatically stored to the Flash Prom for full data retention in power-down state

5.4. Basic Modes of Operation

5.4.1. Normal SSI display

Normal operation provides calculation of the display value from the SSI encoder data and the settings of the scaling factors. Negative values can be achieved by corresponding setting of the zero-position, or by inversion of the direction bit.

To set the unit up without problem, it is best to use the following sequence of steps:

- Set all basic registers according to the encoder type you use, as shown in section 4.1.
- For better comprehension, use first all initial settings as shown in the list (xxx = according to need)

M-Factor	: 1.000	Direction	: 0
D-Factor	: 1.000	Error	: xxx
P-Factor	: 0	Error P	: xxx
Decimal Point	: 000000	Round-Loop	: 0
Display	: 0	Time	: xxx
Hi bit	: see 5.2 and 5.3 *)	Reset	: no
Lo bit	: see 5.2 and 5.3 *)	0-Position	: 0

*) Please evaluate 19 bits only to avoid overflow

These settings ensure that the unit displays the pure SSI encoder information at first.

- Move your encoder now from a “lower” position towards a “higher” position according to your own definition of "low" and "high". When also the display changes from lower to higher values, your own definition of directions matches with the encoder definition. If not, change the setting of “Direction” from “0” to “1” now to receive the desired sense of direction (changes after further parameter settings may cause different results) **)
- Set the desired zero position, either by entering the numeric value to the “0-Position” register, or by using the Reset function as described previously. Your zero definition will divide the range into a positive and a negative zone.
- At this time you are free to set all other registers according to your needs.

The subsequent drawings show the principle of evaluation with use of a 13 bit single turn encoder, with the direction bit set to either “0” or to “1”, and with the zero position register set to “1024” **)

**) Subject of correct sequence with parameter settings

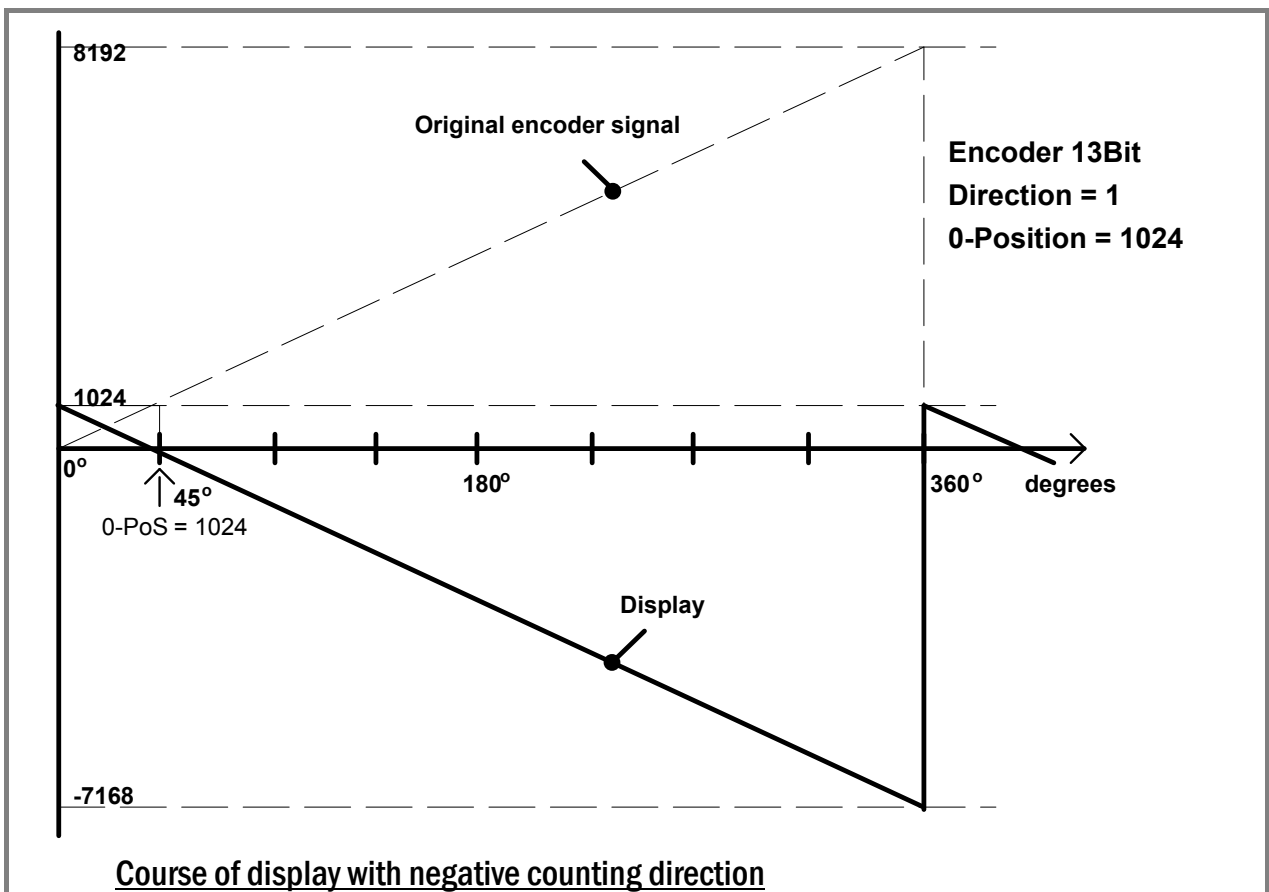
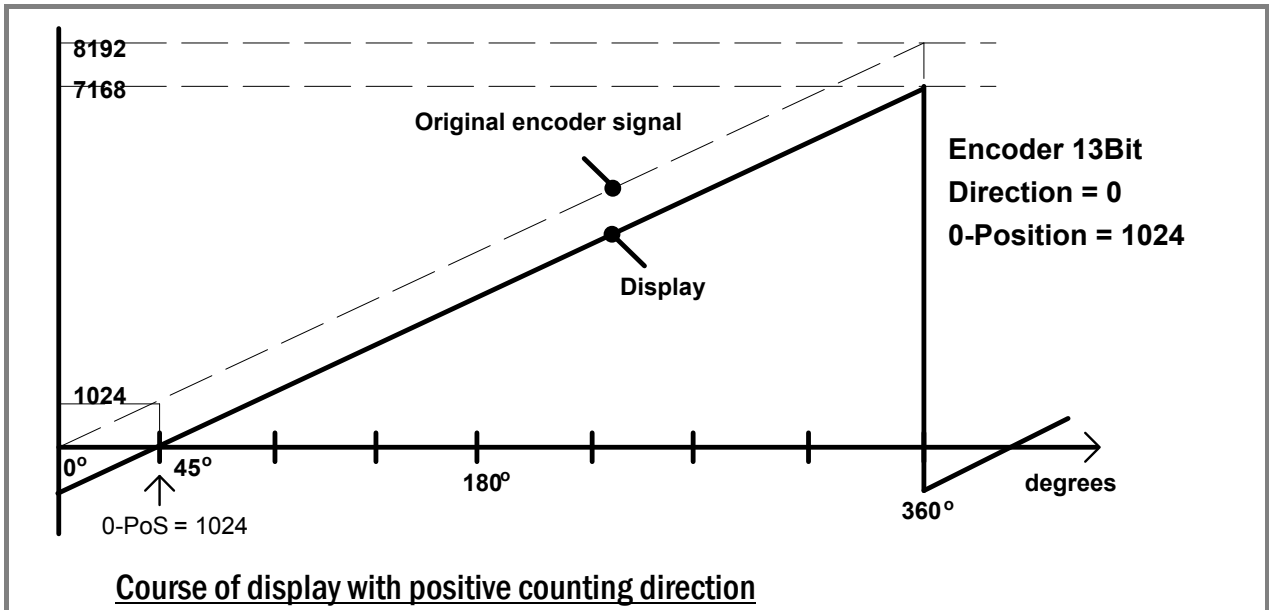

5.4.2. Round-Loop Function

This mode of operation is used frequently with rotating round tables or similar applications, where the absolute encoder information is only used for a limited and repeating range of the encoder (like one revolution of the table, which must not at the same time mean one revolution of the encoder shaft). The Round-Loop Function never uses any negative display values.

The Round-Loop Function allows assigning a programmable number of encoder steps to one full 360° rotation of the table. To avoid miscounting when passing the mechanical overflow of the encoder range, the total encoder resolution should be an integer multiple of the number of steps for one loop.

For setup, please proceed first like shown under section 5.4.1.

Then set register “**r-Loop**” to the number of steps corresponding to one revolution of the table. You are free to scale the display to any engineering units desired, by setting the scaling factors correspondingly.

Where you like to scale your display with the **angular display format 359°59'**, just change the “Display” register from “0” to “359,59”. This will also automatically disable the general scaling factors.

The subsequent diagram shows the round loop function with a 13 bit encoder, where one table revolution corresponds to 2048 encoder steps and where the zero position is set to 1024.

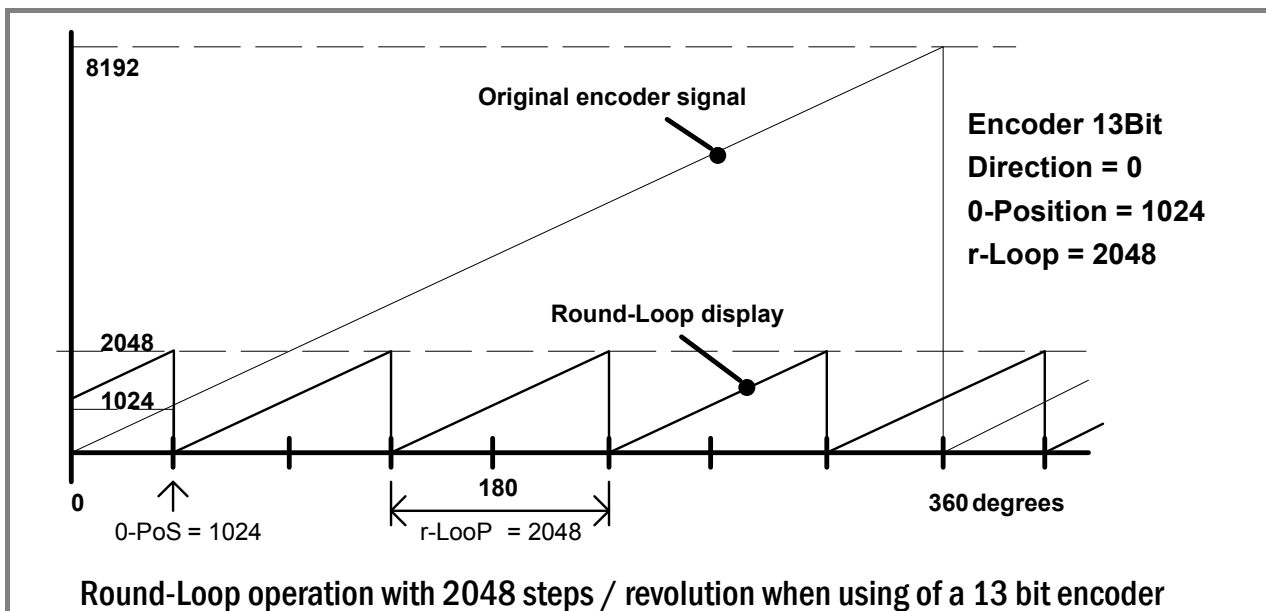

5.4.3. Operation with Zero-Crossing

As a special advantage, the round-loop mode can be used to bypass the mechanical encoder overflow position, because in this mode the unit continues with steady operation, even while the SSI encoder signal passes the mechanical overflow position from maximum to zero. This feature can help to avoid mechanical adjusting of the encoder zero position with many applications, when no other means for the mechanical zero definition is available.

In general the Reset input will be used to define the zero position. The following picture explains the details of operation.

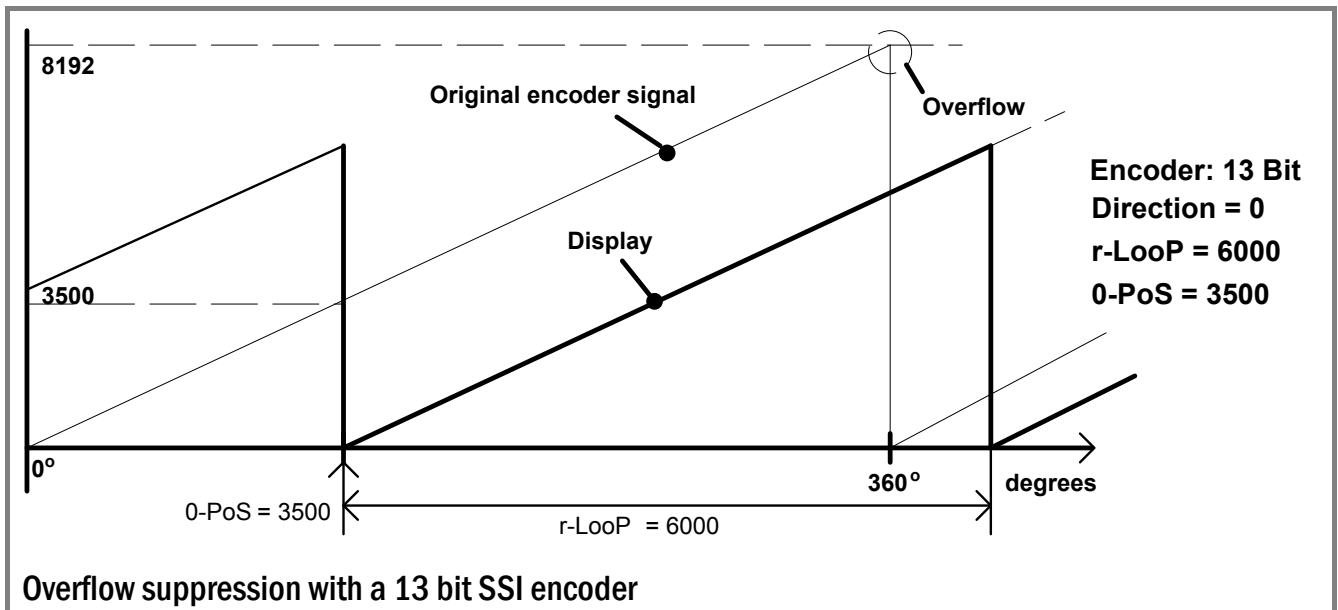





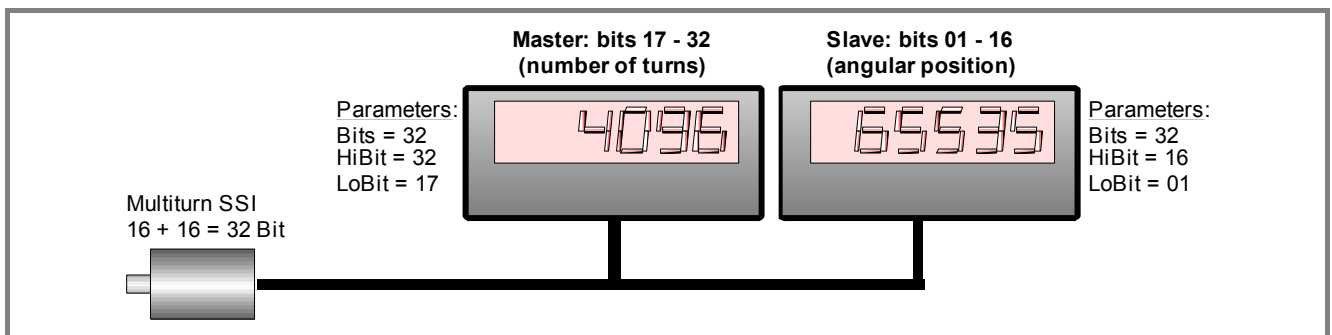

5.4.4. Splitting of SSI Encoder Information into Two Separate Displays

The Bit Blanking Function also allows to distribute one SSI telegram to two different SSI indicator units. As a typical application the figure below shows how to separate the angular information within one turn and the number of turns with a 16 x 16 Multiturn Encoder.









5.5. Testing Functions

The test menu can be accessed while doing the basic set up, as shown in section 4.1. Most of these tests are for factory use only, but the following tests may also be helpful for the user:

Menu	Selection	Text	Description
			Cd (Clock- and data wiring test): When the wiring of clock line and data line is ok, the display shows "Cd 11". Display of "Cd 10" means that the clock line is o.k. but the data wires are false (wrong polarity) and "Cd 01" indicates a problem with the clock lines. With master mode, only the data lines are subject of this test.
			
			Cd (Clock- and data function test): The next test generates clock and data signals and feeds them directly into the rear terminals. Therefore please remove the encoder connection. "Cd i0" says that clock and data interface are all right. and all other displays indicate a problem with the SSI interface circuit.
			
			
			

5.6. Error Messages

The unit can detect and display the errors shown below. If you find an error message, please check again the encoder wiring and the settings of all SSI-relevant parameters.

Menu	Description
	Overflow: The selected SSI Baud Rate is too high. Please set lower rate.
	Error-bit: the error bit or the power failure bit of the encoder (PFB) is set
	Error-time-out: with Slave mode, during the last 0.6 seconds (plus wait time setting) the unit did not receive any valid data.
	Error-Format: with Slave mode, a telegram with too short length has been received.
	Missing encoder (1): right after power-up the unit detects that all SSI telegrams are empty (all bits = 1)
	Missing encoder (2): during normal operation the unit detects that regular SSI telegrams are suddenly followed by empty telegrams (all bits = 1)

6. Special Functions

6.1. Linearization

This function allows converting a non-linear input signal into a linear presentation or vice-versa. There are 16 interpolation points available, which can be freely arranged over the whole measuring range in any distance. Between two points the unit automatically will interpolate straight lines.

It is advisable to set many points into areas with strong bending, and to use only a few points in areas with little bending. „Linearisation Mode“ has to be set to either „1-quA“ or „4-quA“ to enable the linearization function (see subsequent drawing).

Parameters P01_x to P16_x select 16 x- coordinates, representing the display values which the unit would normally show in the display. With parameters P01_y to P16_y you can specify, which values you would like to display instead of the corresponding _x values.

This means e.g. that the unit will replace the previous P02_x value by the new P02_y value.



- With respect to the consistency of the linearization, the x- registers have to use continuously increasing values, e.g. the x- registers must conform to the constraint $P01_X < P02_X < \dots < P15_X < P16_X$.
- Independent of the selected linearization mode, the possible setting range of all registers P01_x, P01_y, ..., P16_x, P16_y is always -199999 ... 999999
- With measuring values lower than P01_x the display will always be P01_y
- With measuring values higher than P16_x, the display will always be P16_y.

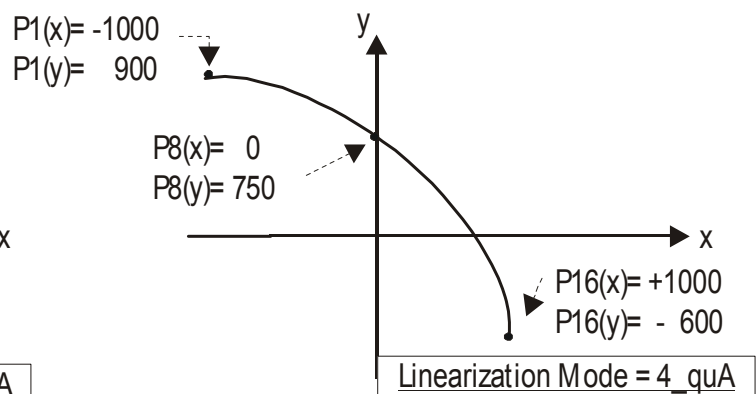
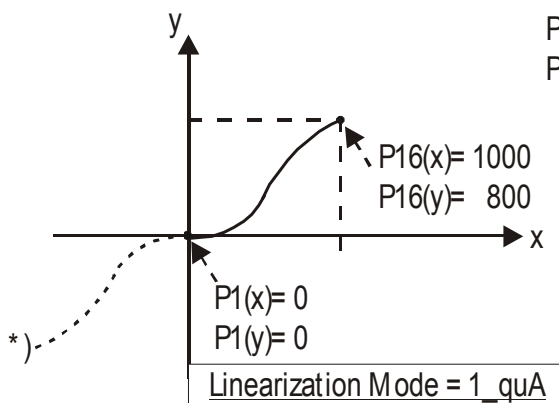

*) Mirror of positive range

Application Example:

The picture below shows a Watergate where the opening is picked up by means of an SSI encoder. We would like to display the clearance of the gate "d", but the existing encoder information is proportional to the opening angle φ .

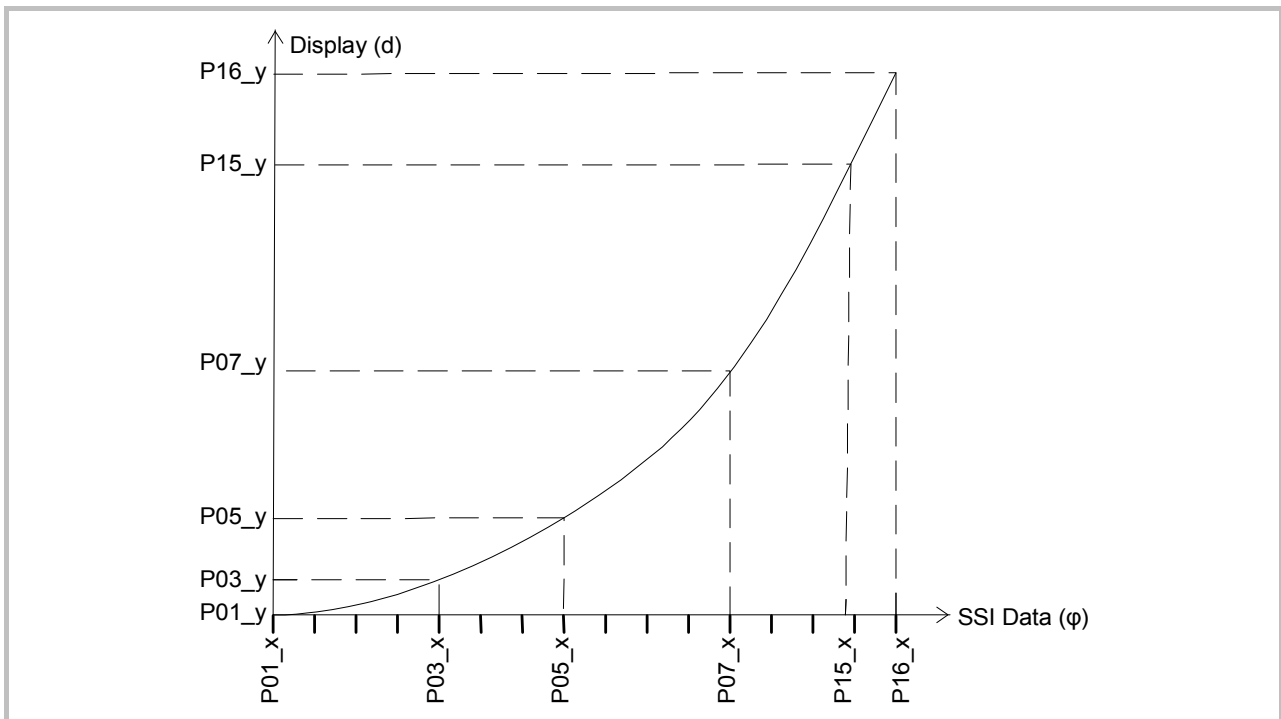
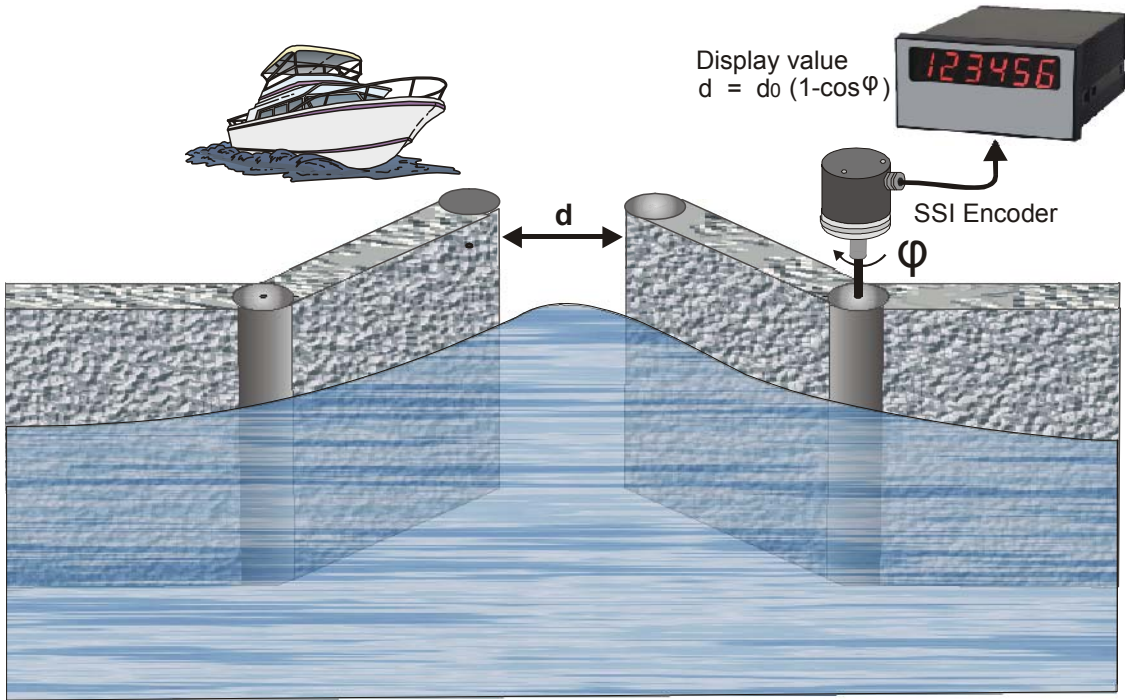

6.2. Manual Input or „Teaching“ of the Interpolation Points

Interpolation points to form the linearization curve can be entered one after another, using the same procedure as for all other numeric parameters. This means you will enter all parameters P01_x to P16_x and P01_y to P16_y manually by keypad.



During manual input of interpolation points the unit will not examine the settings P01_x to P16_x. Therefore the operator is responsible for observation of the constraint $P01_X < P02_X < \dots < P15_X < P16_X$.

In many cases it should however be much more convenient to use the Teach function. For this we need to move the SSI encoder, step by step, from one interpolation point to the next. Every time we enter the desired display value by keypad.

How to use the Teach Function:

- Please select the desired range of linearization (see 4.1).
- Hold down the “Cmd” key for 3 seconds, until the display shows “tEACH”. Now the unit has switched over to the Teach mode. To start the teach procedure please press again “Cmd” within the next 10 seconds. The display will then show “P01_X”.
- With respect to the consistency required for linearization, all parameters from P01_X to P16_Y will first be overwritten by suitable initial values. Initial values for „P01_X“ and „P01_Y“ are -199999 and all other values will start with 999999.
- Press once more “Cmd” to display the actual encoder position. Then move the encoder to the first of the desired interpolation points
- When you read the x-value of your first interpolation point in the display, press “Cmd” again. This will automatically store the actual display value to the P01_x register. For about 1 second you will read “P01_y” on the display, followed by the same reading again that has been stored previously
- This display value now can be edited like a regular parameter, and you can change it to the desired P01_y value
- When you read the desired P01_y value in your display, store it by pressing “Cmd” again. This will automatically cycle the display to the next interpolation point P02_x.

- Once we have reached and stored the last interpolation points P16_x/y, the routine will restart with P01_x again. You are free to double-check your settings once more or to make corrections.
- To conclude the Teach procedure, keep ENTER down for about 2 seconds. In the display you will read “StOP” for a short time, and then the unit returns to the normal operation. At the same time all linearization points have been finally stored.



- The unit will examine the constraint valid for the x-values of interpolation points. Every interpolation point must be higher than its preceding point. Where this constraint is breached, all 6 decimal points will blink automatically as a warning. Pressing the CMD key will not store the illegal value, but result in an error text "E.r.r.-.L.O."
- To exit the teach mode again, you have the following two possibilities:
 1. Press the enter key for 2 seconds. On the display you will read “StOP” for a short time, and then the unit will switch back to the normal mode.
 2. Just do nothing. After 10 seconds the unit will switch back to the normal mode automatically.

In both cases the parameters of linearization P01_X to P16_Y will not change.

7. Technical Appendix

7.1. Dimensions

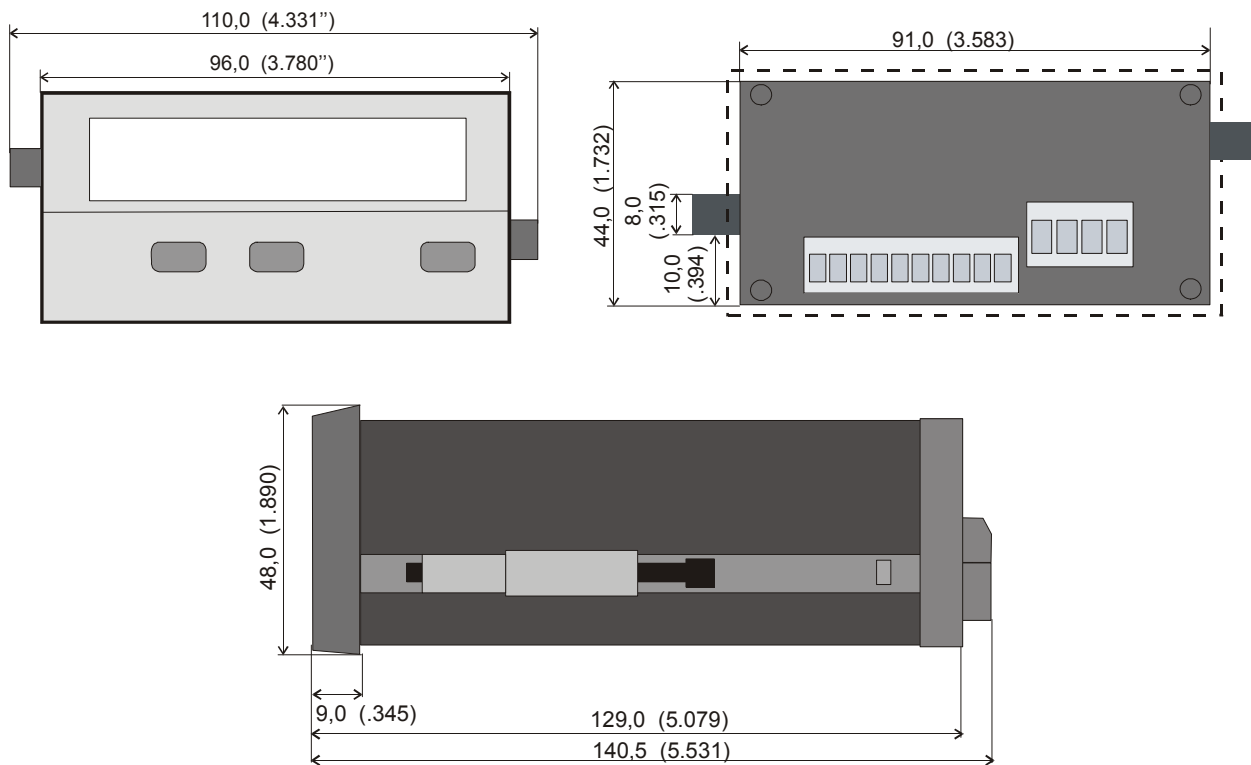

Panel cut out: 91,2 x 44,8 mm (3.59 x 1.76")

7.2. Technical Specifications

Supply voltage AC	: 115/230 V (+/- 12.5 %)
Supply voltage DC	: 24 V (17 - 30 V)
Consumption (without sensor)	: 17 V: 190 mA, 24 V: 150 mA, 30 V: 120 mA
AC Power	: 7.5 VA
Aux. output for encoder	: 24 VDC, +/- 15%, 120 mA (with AC and DC supply)
Control Inputs	: 3 (PNP/NPN/Namur), A / B = unused, C = Reset
Input currents	: 5.1 mA / 24 V (Ri = 4,7 kOhm)
Input level HTL	: Low: 0 ... 2 V, High: 9 ... 35 V
SSI input frequency range	: 100 Hz - 1 MHz
Min. pulse duration for Reset	: 5 msec
Analogue output (WDG 643XIOM)	: 0/4 ... 20 mA, 0...+/- 10 V
Resolution	: 14 Bits + Sign
Accuracy	: 0.1%
Ambient temperature	: Operation: 0° - 45°C (32 - 113°F) Storage: -25° - +70°C (-13 - 158°F)
Housing	: Norly UL94 - V-0
Display	: 6 decades, LED, high- efficiency orange, 15 mm (0.59")
Protection class	: Front IP65, Rear IP20
Terminal cross section	: Signals max. 1.5 mm ² , AC power max. 2.5 mm ²
Switching outputs (WDG 743XIOM)	: PNP, max. 35 volts, max. 150 mA
Conformity and Standards	: EMC 2004/108/EC: EN 61000-6-2 EN 61000-6-3 LV 2006/95/EC: EN 61010-1

7.3. Parameter-List

Denomination	Text	Min - Value	Max - Value	Default - Value	Positions	Characters	Ser. Code
NPN / PNP	CHAr	0	1	1	1	0	05
Brightness	briGht	0	4	0	1	0	06
Code Locking	Code	0	2	0	1	0	07
SSI-Mode	modE	0	1	0	1	0	00
SSI-Bits	bitS	08	32	25	2	0	01
SSI-Format	Form	0	1	0	1	0	02
SSI-Baudrate	bAUd	0.1	1000.9	100.0	5	1	03
SSI-Test	tESt	0	2	0	1	0	04
M-Factor	mFAC	-9.999	+9.999	1.000	+/- 4	3	08
D-Factor	dFAC	0.001	9.999	1.000	4	3	09
P-Factor	PFAC	-199999	+999999	0	+/- 6	0	10
Decimal Point	dPoint	0	5	0	1	0	11
Display	diSPLA	0	1	0	1	0	12
Hi_Bit MSB	Hi_bit	1	32	25	2	0	13
Lo_Bit LSB	Lo_bit	1	32	1	2	0	14
Direction	dir	0	1	0	1	0	15
Error Bit	Error	0	32	0	2	0	16
Error Polarity	ErrorP	0	1	0	1	0	17
Round Loop	r-loopP	0	999999	0	6	0	18
Wait Time	timE	0.000	1.009	0.010	4	3	19
Reset	FErES	0	3	0	1	0	20
Zero Positionn	0-PoS	-199999	+999999	0	+/- 6	0	21
Preselection 1	PrES 1	-199999	+999999	10000	+/- 6	0	27
Preselection 2	PrES 2	-199999	+999999	5000	+/- 6	0	28
Presel. Mode 1	CHAr 1	0	3	0	1	0	29
Presel. Mode 2	CHAr 2	0	5	0	1	0	30
Hysteresis 1	Hyst1	0	99999	0	5	0	36
Hysteresis 2	Hyst2	0	99999	0	5	0	37
Analogue Begin	An-bEG	-199999	999999	0	+/- 6	0	31
Analogue End	An-End	-199999	999999	100000	+/- 6	0	32
Analogue Mode	A-CHAR	0	3	0	1	0	33
Offset	OFFSEt	-9,999	+9,999	0,000	+/- 4	3	34
Gain	GAin	00,00	99,99	10,00	4	2	35

Denomination	Text	Min - Value	Max - Value	Default - Value	Positions	Characters	Ser. Code
Ser. Format	S-Form	0	9	0	1	0	92
Baud Rate	S-bAUd	0	6	0	1	0	91
Ser. Address	S-Unit	0	99	11	2	0	90
Ser. Timer	S-tim	10	9999	100	4	3	38
Ser. Mode	S-mod	0	2	0	1	0	39
Register-Code	S-CodE	100	120	101	3	0	40
Linear. Mode	LinEAR	0	2	0	1	0	D2
Linear. Point 1	P01_H	-199999	999999	999999	+/-6	0	A0
	P01_Y	-199999	999999	999999	+/-6	0	A1
Linear. Point 2	P02_H	-199999	999999	999999	+/-6	0	A2
	P02_Y	-199999	999999	999999	+/-6	0	A3
Linear. Point 3	P03_H	-199999	999999	999999	+/-6	0	A4
	P03_Y	-199999	999999	999999	+/-6	0	A5
Linear. Point 4	P04_H	-199999	999999	999999	+/-6	0	A6
	P04_Y	-199999	999999	999999	+/-6	0	A7
Linear. Point 5	P05_H	-199999	999999	999999	+/-6	0	A8
	P05_Y	-199999	999999	999999	+/-6	0	A9
Linear. Point 6	P06_H	-199999	999999	999999	+/-6	0	B0
	P06_Y	-199999	999999	999999	+/-6	0	B1
Linear. Point 7	P07_H	-199999	999999	999999	+/-6	0	B2
	P07_Y	-199999	999999	999999	+/-6	0	B3
Linear. Point 8	P08_H	-199999	999999	999999	+/-6	0	B4
	P08_Y	-199999	999999	999999	+/-6	0	B5
Linear. Point 9	P09_H	-199999	999999	999999	+/-6	0	B6
	P09_Y	-199999	999999	999999	+/-6	0	B7
Linear. Point 10	P10_H	-199999	999999	999999	+/-6	0	B8
	P10_Y	-199999	999999	999999	+/-6	0	B9
Linear. Point 11	P11_H	-199999	999999	999999	+/-6	0	C0
	P11_Y	-199999	999999	999999	+/-6	0	C1
Linear. Point 12	P12_H	-199999	999999	999999	+/-6	0	C2
	P12_Y	-199999	999999	999999	+/-6	0	C3
Linear. Point 13	P13_H	-199999	999999	999999	+/-6	0	C4
	P13_Y	-199999	999999	999999	+/-6	0	C5
Linear. Point 14	P14_H	-199999	999999	999999	+/-6	0	C6
	P14_Y	-199999	999999	999999	+/-6	0	C7
Linear. Point 15	P15_H	-199999	999999	999999	+/-6	0	C8
	P15_Y	-199999	999999	999999	+/-6	0	C9
Linear. Point 16	P16_H	-199999	999999	999999	+/-6	0	D0
	P16_Y	-199999	999999	999999	+/-6	0	D1

7.4. Commissioning Form

Date		Software:	
Operator:		Serial Number:	
General Setting:	SSI-Mode:	SSI-Bits:	
	SSI-Format:	SSI-Baud Rate (kHz):	
	SSI-Test:		
	Characteristics:	Brightness	
	Code Locking:	Linearization Mode:	
Model WDG 643XIOM	Output Char.:	Analogue Offset:	
	Analogue Gain:		
Model WDG 743XIOM	Presel. Mode 1	Presel. Mode 2:	
	Hysteresis 1	Hysteresis 2:	
Model WDG 843XIOM	Serial Unit Nr:	Serial Format:	
	Serial Baud Rate:		
Display-Parameters	M-Factor:	Decimal Point:	
	D-Factor:	Display:	
	P-Factor:		
SSI-Special:	SSI-High bit: (MSB):	SSI-Error bit:	
	SSI-Low bit: (LSB):	SSI-E-Bit Polarity	
	SSI-Direction:		
	SSI-Round Loop:	SSI-Reset Function:	
	SSI-Gap Time:	SSI-Offset:	
Zusatz-Parameter:			
Model WDG 643XIOM	Analogue Begin:	Analogue End:	
Model WDG 743XIOM	Preselection 1:	Preselection 2:	
Model WDG 843XIOM	Serial Timer:	Serial Printer Mode:	
	Serial Register Code:		

