

UR4848xA

Universal Controller



User manual
Revision L, January 2020

Table of contents

1	Introduction	6
2	Safety guidelines.....	6
2.1	Organization of safety notices.....	6
2.2	Safety Precautions	6
2.3	Precautions for safe use.....	7
2.4	Environmental policy / WEEE	7
3	Model Identification.....	8
4	Technical Data.....	8
4.1	General Features	8
4.2	Hardware Features	8
4.3	Software Features	9
4.4	Programming mode.....	9
5	Dimensions and Installation.....	9
6	Electrical wirings.....	9
6.1	Wiring diagram.....	10
7	Display and Key Functions.....	14
7.1	Numeric Indicators (Display).....	14
7.2	Meaning of Status Lights (Led).....	14
7.3	Keys.....	14
8	Dual input mode.....	15
8.1	Selection of process value related to the command output and to the alarms.....	15
8.2	Remote setpoint by analogue input.....	15
8.3	Remote setpoint by serial input.....	15
9	Controller Functions.....	16
9.1	Modification of main and alarm setpoint value	16
9.2	Automatic Tune	16
9.3	Manual Tune.....	16
9.4	Tuning once	16
9.5	Synchronized tuning	17
9.6	Digital input functions.....	17
9.7	Automatic / Manual regulation for % output control.....	18
9.8	Heater Break Alarm on CT (current transformer - only on UR48482A/3A/4A/5A)	18
9.9	Dual Action (Heating-Cooling).....	19
9.10	LATCH ON Function	20
9.11	Soft-Start Function.....	21
9.12	Pre-Programmed cycle	21
9.13	Retransmission function on analogue output.....	21
10	Serial communication	22
11	Reading and configuration through NFC.....	28
12	Access configuration.....	29
12.1	Loading default values	29
12.2	Parameters list functioning	29
13	Table of Configuration Parameters	30
	GROUP A - PI .1 - Analogue input 1	30
	GROUP B - PI .2 - Analogue input 2 (only on UR48483A/4A).....	32
	GROUP C - PI .1 - Outputs and regulation Process 1	34
	GROUP D - PI .2 - Outputs and regul. Process 2 (only on UR48483A/4A).....	36
	GROUP E - PI .1 - Autotuning and PID 1	38
	GROUP F - PI .2 - Autotuning and PID 2 (only on UR48483A/4A).....	40
	GROUP G - AL .1 - ALARM 1.....	43
	GRUPPO H - AL .2 - Alarm 2.....	45
	GROUP I - AL .3 - Alarm 3.....	47
	GROUP J - AL .4 - Alarm 4.....	49
	GROUP K - AL .5 - Alarm 5 (only on UR48483A/4A/5A)	51

GROUP L - AL 6 - Alarm 6 (only on UR48483A/4A)	54
GROUP M - d.i. 1 - Digital input 1	56
GROUP N - d.i. 2 - Digital input 2	57
GROUP O - d.i. 3 - Digital input 3 (only on UR48483A/4A)	58
GROUP P - d.i. 4 - Digital input 4 (only on UR48483A/4A)	59
GROUP Q - SFS - Soft-start and mini cycle	60
GROUP R - d.SP - Display	61
GROUP S - ct - Current transformer (only on UR48483A/4A/5A)	63
GROUP T - R.o. 1 - Retransmission 1	64
GROUP U - R.o. 2 - Retransmission 2 (only on UR48483A/4A)	65
GROUP V - SER - Seriale (not available on UR48481A)	66
GROUP W - t.ir - Timer	67
14 Alarm Intervention Modes	68
14.1 Alarms label	70
15 Table of Anomaly Signals	70

1 Introduction

The process controller UR4848xA stands out for the bright display which ensures optimal visibility and increased level of information for the operator beside a scrolling Help function.

UR4848xA relies on Wachendorff flagship programming mode by NFC/RFID technology with dedicated App Wachendorff EMG for Android devices (same already used for OLED-Wachendorff indicators) not requiring wirings and power supply, allowing quick set-up/updates on site.

Availability include a model with dual analogue input and dual analogue output for maximum flexibility of applications. It is possible to achieve two separate heating/cooling PID control loops in one device or to handle mathematical operations between two process values.

The outputs can be selected as command/multiple alarm modes/analogue retransmission. Serial communication standard is RS485 with Modbus RTU/Slave protocol. Useful power supply with extended range 24 to 230VAC / VDC with galvanic insulation of the net for the single loop version, while the model with double analogue input provides two versions: 115 / 230 VAC or 24 VAC / VDC.

2 Safety guidelines

Read carefully the safety guidelines and programming instructions contained in this manual before connecting/using the device.

Disconnect power supply before proceeding to hardware settings or electrical wirings to avoid risk of electric shock, fire, malfunction.

Do not install/operate the device in environments with flammable/explosive gases.

This device has been designed and conceived for industrial environments and applications that rely on proper safety conditions in accordance with national and international regulations on labour and personal safety. Any application that might lead to serious physical damage/ life risk or involve medical life support devices should be avoided.

Device is not conceived for applications related to nuclear power plants, weapon systems, flight control, mass transportation systems.

Only qualified personnel should be allowed to use device and/or service it and only in accordance to technical data listed in this manual.

Do not dismantle/modify/repair any internal component.

Device must be installed and can operate only within the allowed environmental conditions. Overheating may lead to risk of fire and can shorten the lifecycle of electronic components.

2.1 Organization of safety notices

Safety notices in this manual are organized as follows:

Safety notice	Description
Danger!	Disregarding these safety guidelines and notices can be life-threatening.
Warning!	Disregarding these safety guidelines and notices can result in severe injury or substantial damage to property.
Information!	This information is important for preventing errors.

2.2 Safety Precautions

This product is UL listed as open type process control equipment. Danger!

If the output relays are used past their life expectancy, contact fusing or burning may occasionally occur.

Always consider the application conditions and use the output relays within their rated load and electrical life expectancy. The life expectancy of output relays varies considerably with the output load and switching conditions. Danger!

Loose screws may occasionally result in fire.

For screw terminals of relays and of power supply, tighten screws to tightening torque of 0,51 Nm. For other terminals, tightening torque is 0,19 Nm Warning!

A malfunction in the Digital Controller may occasionally make control operations impossible or prevent alarm outputs, resulting in property damage. To maintain safety in the event of malfunction of the Digital Controller, take appropriate safety measures, such as installing a monitoring device on a separate line. Warning!

2.3 Precautions for safe use

Be sure to observe the following precautions to prevent operation failure, malfunction, or adverse affects on the performance and functions of the product. Not doing so may occasionally result in unexpected events. Do not handle the Digital Controller in ways that exceed the ratings.

- The product is designed for indoor use only. Do not use or store the product outdoors or in any of the following places.
 - Places directly subject to heat radiated from heating equipment.
 - Places subject to splashing liquid or oil atmosphere.
 - Places subject to direct sunlight.
 - Places subject to dust or corrosive gas (in particular, sulfide gas and ammonia gas).
 - Places subject to intense temperature change.
 - Places subject to icing and condensation.
 - Places subject to vibration and large shocks.
- Installing two or more controllers in close proximity might lead to increased internal temperature and this might shorten the life cycle of electronic components. It is strongly recommended to install cooling fans or other air-conditioning devices inside the control cabinet.
- Always check the terminal names and polarity and be sure to wire properly. Do not wire the terminals that are not used.
- To avoid inductive noise, keep the controller wiring away from power cables that carry high voltages or large currents. Also, do not wire power lines together with or parallel to Digital Controller wiring. Using shielded cables and using separate conduits or ducts is recommended. Attach a surge suppressor or noise filter to peripheral devices that generate noise (in particular motors, transformers, solenoids, magnetic coils or other equipment that have an inductance component). When a noise filter is used at the power supply, first check the voltage or current, and attach the noise filter as close as possible to the Digital Controller. Allow as much space as possible between the Digital Controller and devices that generate powerful high frequencies (high-frequency welders, high-frequency sewing machines, etc.) or surge.
- A switch or circuit breaker must be provided close to device. The switch or circuit breaker must be within easy reach of the operator, and must be marked as a disconnecting means for the controller.
- The device must be protected by a fuse 1A (cl. 9.6.2).
- Wipe off any dirt from the Digital Controller with a soft dry cloth. Never use thinners, benzine, alcohol, or any cleaners that contain these or other organic solvents. Deformation or discoloration may occur.
- The number of non-volatile memory write operations is limited. Therefore, use EEprom write mode when frequently overwriting data, e.g.: through communications.

2.4 Environmental policy / WEEE

Do not dispose electric tools together with household waste material.

According to European Directive 2002/96EC on waste electrical and electronic equipment and its implementation in accordance with national law, electric tools that have reached the end of their life must be collected separately and returned to an environmentally compatible recycling facility.

3 Model Identification

The UR4848xA series includes 5 versions:

Models with power supply 24..230 VAC/VDC ±15% 50/60 Hz – 6 Watt/VA	
UR48481A	1 analogue input + 2 relays 2 A + 2 SSR + 2 D.I. + 1 analogue output V/mA
UR48482A	1 analogue input + 2 relays 2 A + 2 SSR / D.I. + 1 analogue output V/mA + RS485
UR48485A	1 analogue input + 3 relays 2 A + 2 SSR + 2 D.I. + 1 analogue output V/mA
Model with power supply 24 VAC/VDC ±15% 50/60 Hz – 7 Watt/VA	
UR48483A	2 analogue input + 3 relays 2 A + 2 SSR + 2/4 D.I. + 2 analogue output V/mA + RS485 + CT
Model with power supply 115..230 VAC ±15% 50/60 Hz – 12 Watt/VA	
UR48484A	2 analogue input + 3 relays 2 A + 2 SSR + 2/4 D.I. + 2 analogue output V/mA + RS485 + CT

4 Technical Data

4.1 General Features

Displays	4 digits 0,52", 5 digits 0,30"
Operating temperature	Temperature: 0-45° C -Humidity 35..95 uR%
Sealing	IP65 front panel (with gasket) - IP20 box and terminals
Material	Box and front panel: PC UL94V2 self-extinguishing
Weight	Approx. 185 g

4.2 Hardware Features

Analogue inputs	<p>AI1 – AI2: Configurable via software. Input: Thermocouple type K, S, R, J,T,E,N,B. Automatic compensation of cold junction from -25...85° C. Thermoresistances: PT100, PT500, PT1000, Ni100, PTC 1K, NTC 10K (β 3435K) Input V/mA: 0-1 V, 0-5 V, 0-10 V, 0-20 o 4-20 mA, 0-60 mV. Pot. Input: 1...150 KΩ. CT: 50 mA.</p>	<p>Tolerance (25° C) ± 0.2% ±1 digit (on F.s.) for thermocouple, thermoresistance and V/mA. Cold junction accuracy 0.1° C/°C.</p> <p>Impedence: 0-10 V: Ri>110 KΩ 0-20 mA: Ri<5 Ω 0-40 mV: Ri>1 MΩ</p>
Relay outputs	Configurable as command and alarm output.	Contacts: 2 A - 250 VAC Resistive load.
SSR output	Configurable as command and alarm output.	12/24 V, 25 mA.
Analogue outputs	Configurable as command and alarm output or as retrasmision of process / setpoints.	Configurable: 0-10 V with 40000 points +/-0.2% (on F.s.) 4-20 mA con 40000 points +/-0.2% (on F.s.)
Power-supply	<p>For UR48481A/2A/5A: Extended power-supply 24..230 VAC/ VDC ±15% 50/60 Hz For UR48483A: 24 VAC/VDC ±15% 50/60 Hz For UR48484A: 115..230 VAC ±15% 50/60 Hz</p>	<p>Consumption: UR48481A: 6 Watt/VA UR48482A: 9 Watt/VA UR48485A: 8 Watt/VA UR48483A: 7 Watt/VA UR48484A: 12 Watt/VA</p>

4.3 Software Features

Regulation algorithms	ON-OFF with hysteresis. - P, PI, PID, PD with proportional time
Proportional band	0..9999°C or °F
Integral time	0,0..999,9 sec (0 excludes)
Derivative time	0,0..999,9 sec (0 excludes)
Controller functions	Manual or automatic Tuning, selectable alarm, protection of command and alarm setpoints.

4.4 Programming mode

by keyboard	..see paragraph 12
software LabSoftview	..on "Download section" of www.wachendorff-prozesstechnik.de
App Wachendorff EMG	..through download the App on Google Play Store®, see paragraph 11 When activated by a reader/interrogator supporting NFC-V protocol, controller UR4848xA is to be considered a VICC (Vicinity Inductively Coupled Card) according to ISO/IEC 15693 and it operates at a frequency of 13.56 MHz. The device does not intentionally emit radio waves.

5 Dimensions and Installation

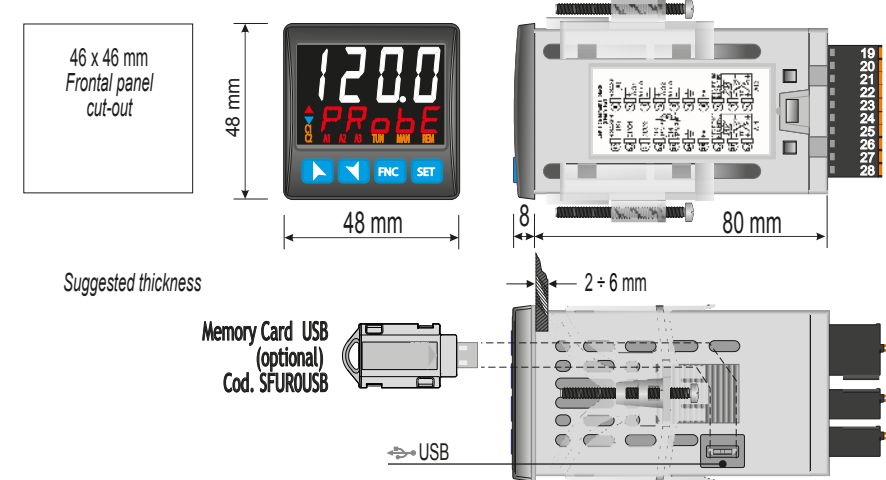

6 Electrical wirings

This controller has been designed and manufactured in conformity to Low Voltage Directive 2006/95/EC, 2014/35/EU (LVD) and EMC Directive 2004/108/EC, 2014/30/EU (EMC). For installation in industrial environments please observe following safety guidelines:

- Separate control line from power wires.
- Avoid proximity of remote control switches, electromagnetic contactors, powerful engines.
- Avoid proximity of power groups, especially those with phase control.
- It is strongly recommended to install adequate mains filter on power supply of the machine where the controller is installed, particularly if supplied 230Vac.

The controller is designed and conceived to be incorporated into other machines, therefore CE marking on the controller does not exempt the manufacturer of machines from safety and conformity requirements applying to the machine itself.

- Wiring of pins 1...8 on UR48481A, UR48482A or UR48485A: use crimped tube terminals or flexible/rigid copper wire with diameter 0.2 to 2.5 mm² (min. AWG28, max. AWG12, operating temperature: min. 70°C). Cable stripping length 7 to 8 mm.

- Wiring of pins 9...19 on UR48481A, UR48482A or UR48485A: use crimped tube terminals or flexible/rigid copper wire with diameter 0.2 to 1.5 mm² (min. AWG28, max. AWG14, operating temperature: min. 70°C). Cable stripping length 6 to 7 mm.
- Wiring of pins 1...8 on UR48483A/4A: use crimped tube terminals or flexible/rigid copper wire with diameter 0.2 to 2.5 mm² (min. AWG26, max. AWG12, operating temperature: min. 70°C). Cable stripping length 10 to 11 mm.
- Wiring of pins 9...28 on UR48483A/4A: use crimped tube terminals or flexible/rigid copper wire with diameter 0.5 to 1 mm² (min. AWG24, max. AWG16, operating temperature: min. 70°C). Cable stripping length 7 to 8 mm.

6.1 Wiring diagram

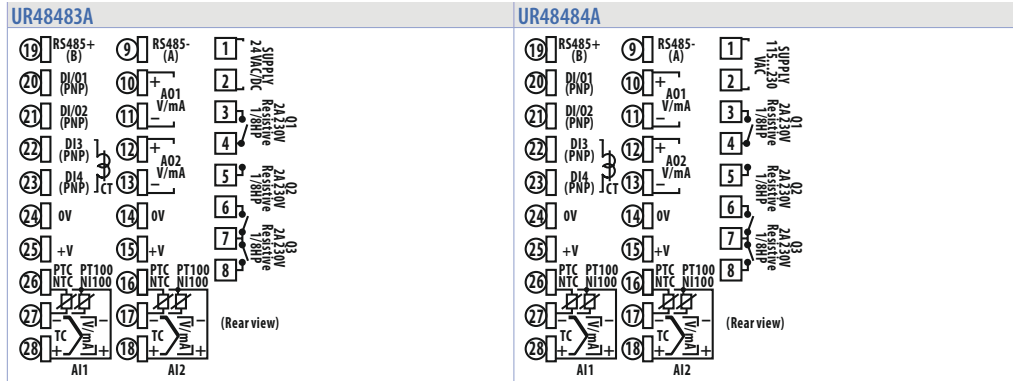
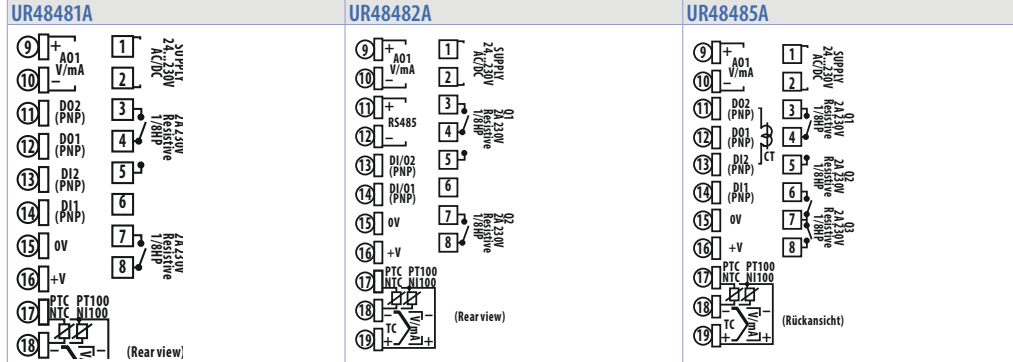

6.a Power Supply

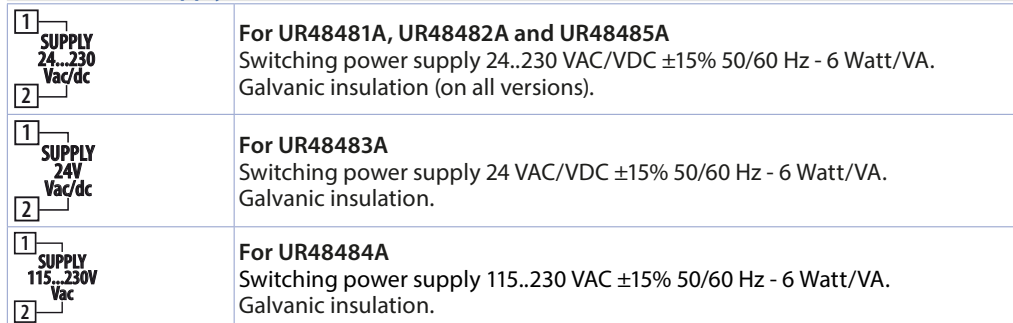

6.1.a Analogue Input AI1

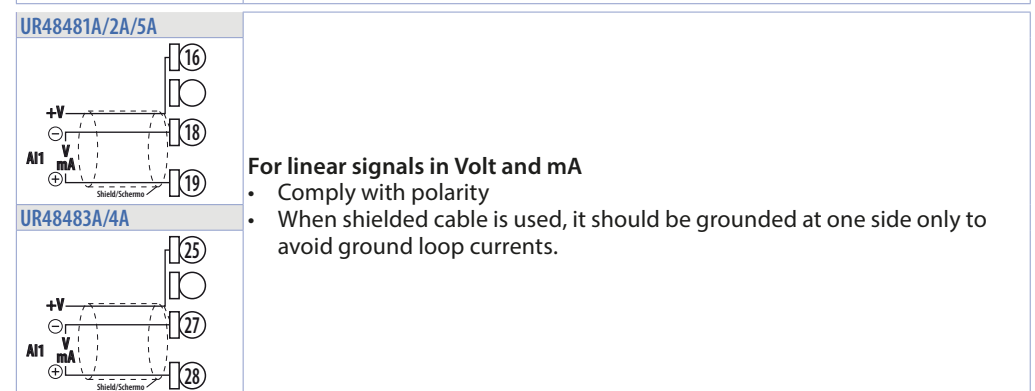
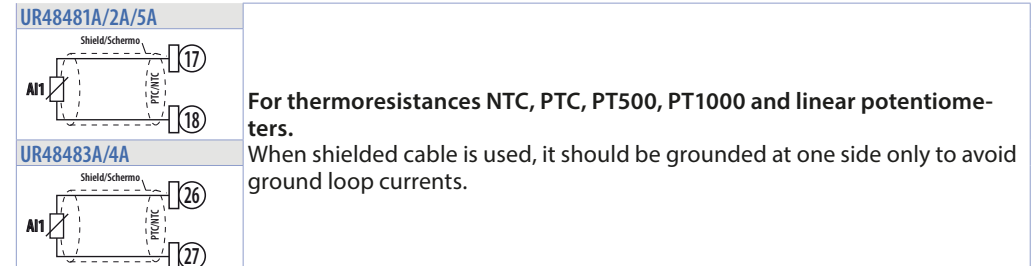
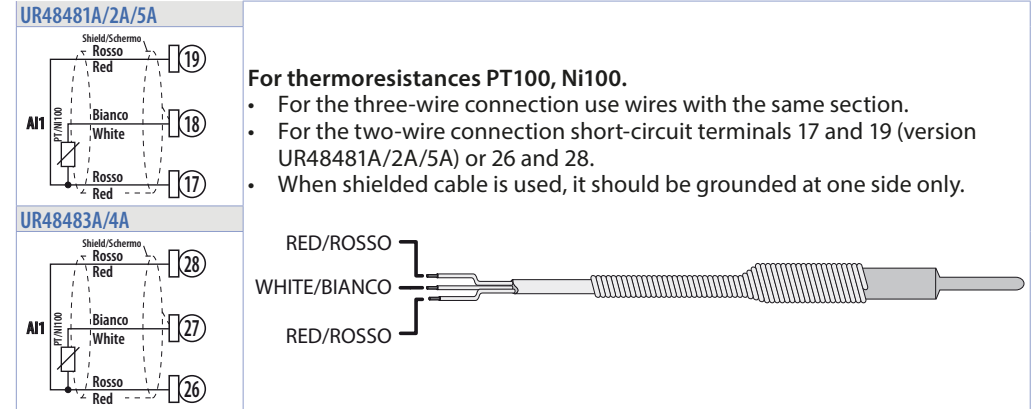
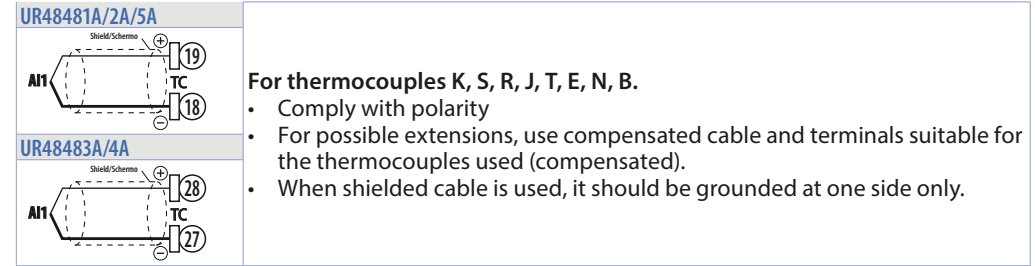

6.1.b Analogue Input AI2 (only UR48483A/4A)

	<p>For thermocouples K, S, R, J, T, E, N, B.</p> <ul style="list-style-type: none"> Comply with polarity For possible extensions, use compensated cable and terminals suitable for the thermocouples used (compensated). When shielded cable is used, it should be grounded at one side only.
	<p>For thermoresistances PT100, Ni100.</p> <ul style="list-style-type: none"> For the three-wire connection use wires with the same section. For the two-wire connection short-circuit terminals 16 and 18. When shielded cable is used, it should be grounded at one side only.
	<p>For thermoresistances NTC, PTC, PT500, PT1000 and linear potentiometers.</p> <p>When shielded cable is used, it should be grounded at one side only to avoid ground loop currents.</p>
	<p>For linear signals in Volt and mA</p> <ul style="list-style-type: none"> Comply with polarity When shielded cable is used, it should be grounded at one side only to avoid ground loop currents.

6.1.c CT-Input (only on UR48483A/4A/5A)

<p>5A</p>	<p>3A/4A</p> <p>To enable CT input, modify parameter 287 <i>ct F</i>.</p> <ul style="list-style-type: none"> Input for 50 mA amperometric transformer. Sampling time 100 ms. Configurable by parameters.
-----------	--

6.b Digital inputs

<p>1A/5A</p>	<p>2A</p>	<p>3A/4A</p> <p>Digital inputs can be enabled by parameters.</p> <p>Close pin "Dlx" on pin "+V" to enable digital input.</p> <p>It is possible to put in parallel the digital inputs of different devices joining together the 0V pins (15).</p>
--------------	-----------	--

6.1.a Serial inputs (only UR48482A/3A/4A)

<p>UR48482A</p>	<p>Modbus RS485 communication. RTU Slave with galvanic insulation.</p>
<p>UR48483A/4A</p>	<p>It is recommended to use the twisted and shielded cable for communications.</p>

6.1.b Digital outputs

<p>1A/5A</p>	<p>2A</p>	<p>3A/4A</p>	<p>Digital output PNP (including SSR) for command or alarm. Range 12 VDC/25 mA or 24 VDC/15mA selectable by parameter 282 <i>u.out</i>.</p>
--------------	-----------	--------------	---

6.1.c Analogue output AO1

<p>UR48481A/2A/5A</p>	<p>Linear output in mA or V (galvanically isolated) configurable as command, alarm or retransmission of process-setpoint.</p>
<p>UR48483A/4A</p>	<p>The selection mA or Volt for the linear output depends on the parameters configuration.</p>

6.1.d Analogue output AO2 (only UR48483A/4A)

	<p>Linear output in mA or V (galvanically isolated) configurable as command, alarm or retransmission of process-setpoint. The selection mA or Volt for the linear output depends on the parameters configuration.</p>
--	---

6.c Relay output Q1

	<p>Capacity 2 A / 250 VAC for resistive loads. See chart below.</p>
--	---

6.1.a Relay output Q2 (only UR48481A/2A)

	<p>Capacity 2 A / 250 VAC for resistive loads. See chart below.</p>
--	---

6.d Relays output Q2 - Q3 (only on UR48483A/4A/5A)

	<p>Capacity 2 A / 250 VAC for resistive loads. See chart below.</p>
--	---

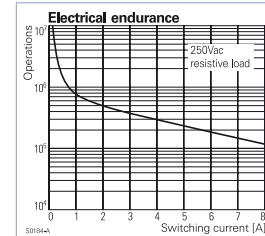

Electrical endurance Q1, Q2 e Q3:
2 A, 250 VAC, resistive loads, 10⁵ operations.
20/2 A, 250 VAC, cosφ = 0.3, 10⁵ operations.

7 Display and Key Functions

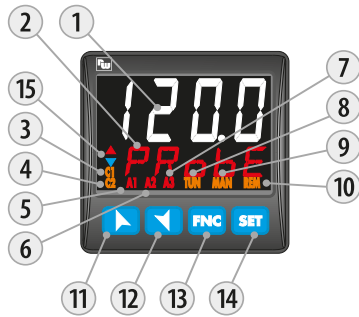

7.1 Numeric Indicators (Display)

1	1234	Normally displays the process. During the configuration phase, it displays the parameter being inserted.
2	Probe	Normally displays the setpoint. During the configuration phase, it displays the parameter value being inserted.

7.2 Meaning of Status Lights (Led)

3	C1	ON when the command output 1 is active. In case of motorized valve control it is ON during valve opening and flashes during valve closing.
4	C2	ON when the command output 2 is active. In case of motorized valve control it is ON during valve opening and flashes during valve closing.
5	A1	ON when alarm 1 is active.
6	A2	ON when alarm 2 is active.
7	A3	ON when alarm 3 is active.
8	TUN	ON when the controller is executing an auto-tuning cycle.
9	MAN	ON when "Manual" function is active.
10	REM	ON when the controller communicates through serial. Flashes when the remote setpoint is enabled.

7.3 Keys

11	▲	<ul style="list-style-type: none"> Increases the main setpoint. During configuration allows to scroll the parameters or the groups of parameters. Increases the setpoints.
12	▼	<ul style="list-style-type: none"> Decreases the main setpoint. During configuration allows to scroll the parameters or the groups of parameters. Decreases the setpoints.
13	SET	<ul style="list-style-type: none"> Allows to visualize command and alarm setpoints. During configuration allows to enter the parameter to be modified and confirms the variation.
14	FNC	<ul style="list-style-type: none"> Allows to enter the Tuning launch function, automatic/manual selection. During configuration works as exit key (ESCAPE).
15	▲	<ul style="list-style-type: none"> ON during the rising phase of the pre-programmed cycle; ON during the falling phase of the pre-programmed cycle; Both ON during parameter modification, when this is not a default value.
	▼	
	▲▼	

8 Dual input mode

Each UR48483A/4A model is provided with two analogue inputs: it is possible to do mathematic operations between 2 measured process values, correlating obtained result to the command or alarm outputs, or to give a process value as remote setpoint. It is also possible to use the controller for 2 independent control loops.

8.1 Selection of process value related to the command output and to the alarms

When second analogue input is enabled (par.18 $SEn.2$ other than $d.5Ab$) it is possible to choose the process value to be related to command output, to alarms and to retransmission.

Following options are available:

- $R.in.1$: Value read by input AI1;
- $R.in.2$: Value read by input AI2;
- $MEAN$: Mean between inputs AI1 and AI2;
- $d.dFF$: Difference between inputs: AI1-AI2;
- $Ab.d.dF$: Difference between inputs as absolute value: AI1-AI2;
- Command 1 process must be selected on parameter 36 $c.Pr.1$
- Command 2 process must be selected on parameter 55 $c.Pr.2$
- The process related to the alarms must be selected on par. 124 $R.1.Pr.$ for the alarm 1, on par. 142 $R.2.Pr.$ for the alarm 2, on par. 160 $R.3.Pr.$ for the alarm 3, and on par. 178 $R.4.Pr.$ for the alarm 4, on par. 196 $R.5.Pr.$ for the alarm 5 and on par. 214 $R.6.Pr.$ for the alarm 6.
- The value to be retransmitted must be selected on par. 299 $r.t.1$ and/or on par. 308 $r.t.2$.

It is possible to choose what to visualize on display 2 selecting par. 278 $u.i.d.2$.

8.2 Remote setpoint by analogue input

It is possible to enable remote setpoint function setting $EnAb.$ or $En.tSt.$ on par. 56 $rEn.5$.

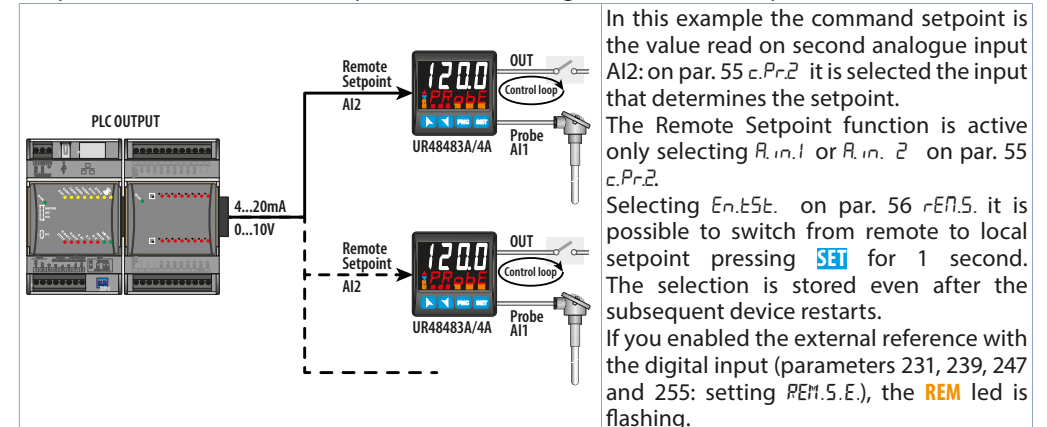

The decimal point setting parameter for the image input (or remote setpoint) is locked and modifies automatically when the command input decimal point is changed.

8.3 Remote setpoint by serial input

It is possible to enable remote setpoint function selecting $En.5Er.$ or $En.5Et.$ on par. 56 $rEn.5$. The remote setpoint must be written on the word modbus 1249 for the command 1 and 1250 for the command 2 (with tenth of degree if the command process is a temperature sensor).

It is possible to switch from remote to local setpoint pressing **SET** for 1 second. In remote setpoint mode the led **REM** is ON (if there is serial communication), it flashes when switching to local setpoint mode. At restarting the controller keeps set in remote setpoint mode (the setpoint value is initialized to 0).

9 Controller Functions

9.1 Modification of main and alarm setpoint value

Setpoint value can be modified from keyboard as follows:

	Press	Display	Do
1		Value on display 2 changes.	Increases or decreases the main setpoint value.
2	SET	Visualizes the other setpoints on display 1. Display 2 shows the setpoint type.	
3		Value on display 1 changes.	Increases or decreases the alarm setpoint value.

9.2 Automatic Tune

Automatic tuning procedure allows a precise regulation without delving into the PID regulation algorithm. Selecting Auto on par. 73 $t_{un.1}$ (for the regulation loop 1), or on par. 98 $t_{un.2}$ (for the regulation loop 2), the controller analyzes the proces oscillations and optimizes the PID parameters. Led **TUN** flashes.

If the PID parameters are not yet selected, at the device switch-on, it is automatically launched the manual Tuning procedure described into the next paragraph.

9.3 Manual Tune

Manual procedure allows the user greater flexibility to decide when to update PID algorithm parameters. During the manual tuning, the device generates a step to analyze the system inertia to be regulated and, according to the collected data, modifies PID parameters.

After selecting \overline{PRNU} on par. 73 $t_{un.1}$, or on par. 98 $t_{un.2}$, the procedure can be activated in three ways:

- **Running Tuning by keyboard:**
Press **ENC** until display 2 shows t_{unE} with display 1 on dis. and then press **SET**: display 1 shows Enab. Led **TUN** switches ON and the procedure starts.
- **Running Tuning by digital input:**
Select t_{unE} on par. 231 $d_{.i.1F}$ (or on par. 239 $d_{.i.2F}$, par. 247 $d_{.i.3F}$, par. 255 $d_{.i.4F}$). At first activation of digital input (commutation on front panel) led **TUN** led switches on and at second activation switches off.
- **Running Tuning by serial input:**
Write 1 on word modbus 1216 (command 1) or 1217 (command 2): led **TUN** switches ON and the procedure starts. Write 0 to stop the tuning.

To avoid an overshoot, the treshold where the controller calculates new PID parameters is determined by this operation:

Tune threshold = Setpoint - "Set Deviation Tune" (par. 74 $S_{d.t.1}$ or par. 99 $S_{d.t.2}$)

Ex.: if the sepoint is 100.0°C and the Par.32 $S_{d.t.1}$ is 20.0°C the threshold to calculate PID parameters is (100.0 - 20.0) = 80.0°C.

For a greater precision on PID parameters calculation it is suggested to start the manual tuning procedure when the process deviates from the setpoint.

9.4 Tuning once

Set \overline{ONCE} on parameter 73 $t_{un.1}$, or on parameter 98 $t_{un.2}$.

Autotuning procedure is executed only once at next UR4848xA restart. If the procedure doesn't work, will be executed at next restart.

9.5 Synchronized tuning

Set \overline{Synch} on parameter 73 $t_{un.1}$ or on parameter 98 $t_{un.2}$.

This procedure has been conceived to calculate correct PID values on multi-zone systems, where each temperature is influenced by the adjacent zones.

Writing on word modbus 1216 (for regulation loop 1) or 1217 (for regulation loop 2) the controller works as follows:

Word value	Action
0	Tune off
1	Command output OFF
2	Command output ON
3	Tune active
4	Tune completed: command output OFF (read only)
5	Tune not available: softstart function enabled (only reading)

Here below the functioning for regulation loop 1: the master switches-off or turns-on all zones (value 1 or 2 on word 1216) for a time long enough to create inertia on the system.

At this point the autotuning is launched (value 3 on word 1216). The controller executes the procedure for the calculation of the new PID values. When the procedure ends, the controller switches off the command output and selects the value 4 on word 1216. The master, who will always read the word 1216, will control the various zones and when all will have finished, will bring to 0 the value of word 1216: the various devices will regulate the temperature independently, with the new calculated values. N.B. The master must read the Index 0x400E at least every 10 seconds or the controller will automatically exit the autotuning procedure.

9.6 Digital input functions

The UR4848xA functions related to digital inputs, can be enabled by parameters 231 $d_{.i.1F}$, 239 $d_{.i.2F}$, 247 $d_{.i.3F}$ and 255 $d_{.i.4F}$.

- $2t_{SU}$: Two threshold setpoint modification: with digital input active the UR4848xA regulates on **SET2**, otherwise reulates on **SET1**;
- $2t_{SU}$: Modification of 2 setpoints by digital input with impulse command;
- $3t_{SU}$: Modification of 3 setpoints by digital input with impulse command,
- $4t_{SU}$: Modification of 4 setpoints by digital input with impulse command,
- $S_{t.rSt}$: Start / Stop of the controller by digital input with impulse command,
- r_{un} : The regulation is enabled only with digital input active,
- $Hold$: With digital input active the conversion is locked (visualization maintenance function);
- t_{unE} : Enables/disables the Tuning if par. 73 $t_{un.1}$ or par. 98 $t_{un.2}$ is selected as \overline{PRNU} ;
- $R_{u.NR.i}$: If par. 48 $R_{.NR.1}$ or par. 67 $R_{.NR.2}$ is selected as $EnAb$ or $EnSto.$, with impulse command on digital input, the UR4848xA switches the related regulation loop, from automatic to manual and vice versa.
- $R_{u.NR.c}$: If par. 48 $R_{.NR.1}$ or par. 67 $R_{.NR.2}$ is selected as $EnAb$ or $EnSto.$ the UR4848xA switches to manual the related regulation loop, with digital input active, otherwise the regulation is automatic.
- $R_{ct.ty}$: On the regulation loop selected for this function (par. 234 $d_{.i.1r}$ or 242 $d_{.i.2r}$ or 250 $d_{.i.3r}$ or 258 $d_{.i.4r}$), the UR4848xA execute a cooling type regulation with digital input active, otherwise the regulation is of heating type;
- $R_{.i.0}$: Zero tare function: brings the related analogue input to 0. The analogue input is selected on par. 233 $d_{.i.1P}$ or 241 $d_{.i.2P}$ or 249 $d_{.i.3P}$ or 257 $d_{.i.4P}$.
- \overline{rES} : Allows the reset of the output if manual reset is active for the alarms and for the command outputs selected on par. 234 $d_{.i.1r}$ or 242 $d_{.i.2r}$ or 250 $d_{.i.3r}$ or 258 $d_{.i.4r}$;
- $t_{.1run}$: If timer 1 is enabled (par. 328 $t_{Pr.1}$ different from $d_{.i5Ab}$), with digital input active, the timer is switched to RUN, otherwise is kept in STOP;
- $t_{.1SE}$: If timer 1 is enabled (par. 328 $t_{Pr.1}$ different from $d_{.i5Ab}$), acting on the digital input, the status of the timer switches from STOP to RUN e vice versa;
- $t_{.1SA}$: If timer 1 is enabled (par. 328 $t_{Pr.1}$ different from $d_{.i5Ab}$), acting on the digital input, the timer is switched to RUN;
- $t_{.1End}$: If timer 1 is enabled (par. 328 $t_{Pr.1}$ different from $d_{.i5Ab}$), acting on the digital input, the

timer is switched to STOP;

- $t_{2.run}$: If timer 2 is enabled (par. 331 $t_{nr.2}$ different from d_{5Ab}), with digital input active, the timer is switched to RUN, otherwise is kept in STOP;
- $t_{25.E}$: If timer 2 is enabled (par. 331 $t_{nr.2}$ different from d_{5Ab}), acting on the digital input, the status of the timer switches from STOP to RUN e vice versa;
- t_{25tA} : If timer 2 is enabled (par. 331 $t_{nr.2}$ different from d_{5Ab}), acting on the digital input, the timer is switched to RUN;
- t_{2End} : If timer 2 is enabled (par. 331 $t_{nr.2}$ different from d_{5Ab}), acting on the digital input, the timer is switched to STOP;
- $Lo.cFL$: With digital input active, the access to setpoint configuration/modification is locked;
- $rEN.S.E$: If on par. 56 $rEN.S$ it is selected $EnAb$ or $EnSEr$, with digital input active the remote setpoint is enabled, otherwise the setpoint is local. On par. 234 $d_{i.l.r}$ or 242 $d_{i.2.r}$ or 250 $d_{i.3.r}$ or 258 $d_{i.4.r}$ it is necessary to select the reference regulation loop.

9.7 Automatic / Manual regulation for % output control

This function allows to switch from automatic functioning to manual command of the output percentage.

With par. 48 $R_{PA.1}$ (for regulation loop 1) or par. 67 $R_{PA.2}$ (for regulation loop 2) it is possible to select two modes.

1 **First selection** ($EnAb$) allows to enable with **FNC** the writing P_{--- on display 1, while on display 2 is showed A_{utof} .

Press **SET** to visualize n_{anu} ; it's now possible, during the process visualization, modify through the keys **A** and **V** the output percentage. To back to automatic, with the same procedure, select A_{utof} on display 2: immediately led **MAN** switches off and functioning backs to automatic.

2 **Second selection** ($EnSEo$) enables the same functioning but with two important variants:

- If there is a temporary power failure or after switch-off, the manual functioning as well as the previous output percentage value will be maintained at restarting.
- If the sensor breaks during automatic functioning, the controller switches to manual mode while maintaining the output percentage command unchanged as generated by the PID immediately before breakage.

Ex: on an extruder the command in percentage of the resistance (load) is maintained also in case of input sensor failure.

9.8 Heater Break Alarm on CT (current transformer - only on UR48483A/4A/5A)

This function allows to measure load current to manage an alarm during a malfunctioning with power in short circuit, always open or partial break of the charge. To enable this function set $S_0 H_2$ or $S_0 H_2$ on par. 287 $ct.F$ and the value of the connected transformer, on par. 288 $ct.u$.

- Select on par. 289 $H.b.A.r$ the regulation loop referred to the current measure and the Heater Break Alarm intervention.
- Select on par. 290 $H.b.A.t$ the Heater Break Alarm intervention threshold in Ampere.
- Select on par. 291 $oc.u.t$ the intervention threshold in Ampere to control the overcurrent.
- Select on par. 292 $H.b.A.d$ the delay time in seconds for the Heater Break Alarm intervention.
- It is possible to associate an alarm, selecting $H.b.A$ on par. 123 $AL.1F$ on par. 141 $AL.2F$ or par. 159 $AL.3F$ or par. 177 $AL.4F$ or par. 195 $AL.5F$ or par. 213 $AL.6F$.

It is possible to visualize on display 2 the average current, selecting n_{nPEr} on par. 278 $u.i.d.2$.

Selecting 0 on par. 290 $H.b.A.t$ it is possible to visualize the current consumption without generating an Heater Break Alarm.

9.9 Dual Action (Heating-Cooling)

UR4848xA is suitable also for systems requiring a combined heating-cooling action.

The command output has to be configured as PID for Heating (Par. 38 $R_{c.t.1}$ or Par. 57 $R_{c.t.2} = HEAT$ and $P.b.1$ or $P.b.2$ greater than 0), and one of the alarms ($AL.1F$, $AL.2F$, $AL.3F$, $AL.4F$, $AL.5F$ or $AL.6F$) has to be configured as $cool$.

The command output must be connected to the actuator responsible for heating, while the alarm will control cooling action.

Parameters to be configured for the heating PID are:

$R_{c.t.1}$ or $R_{c.t.2} = HEAT$ Command output action type (Heating);

$P.b.1$ or $P.b.2$: Heating proportional band;

$i.t.1$ or $i.t.2$: Integral time of heating and cooling;

$d.t.1$ or $d.t.2$: Derivative time of heating and cooling;

$c.t.1$ or $c.t.2$: Heating time cycle.

Parameters to be configured for the cooling PID related to regulation loop 1 and alarm 1 are:

$AL.1F = cool$. Alarm 1 selection (Cooling);

$P.b.n.t$: Proportional band multiplier;

$o.d.b.t$: Overlapping / Dead band;

$c.c.t.t$: Cooling time cycle.

Par. $P.b.n.1$ (that ranges from 1.00 to 5.00) determines the proportional band of cooling action basing on the formula:

Proportional band for cooling action = $P.b.1 \times P.b.n.1$

This gives a proportional band for cooling which will be the same as heating band if $P.b.n.1 = 1.00$, or 5 times greater if $P.b.n.1 = 5.00$.

Integral and derivative time are the same for both actions.

Par. $o.d.b.1$ determines the percentage overlapping between the two actions. For systems in which the heating output and cooling output must never be simultaneously active a Dead Band ($o.d.b.1 \leq 0$), must be configured, vice versa you can configure an overlapping ($o.d.b.1 > 0$).

The following figure shows an example of dual action PID (heating-cooling) with $i.t.1 = 0$ e $d.t.1 = 0$.

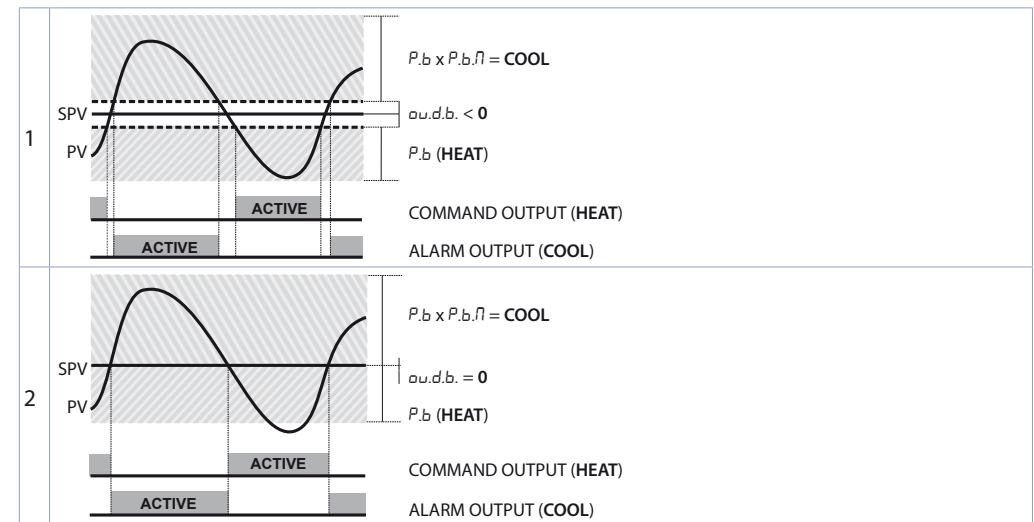

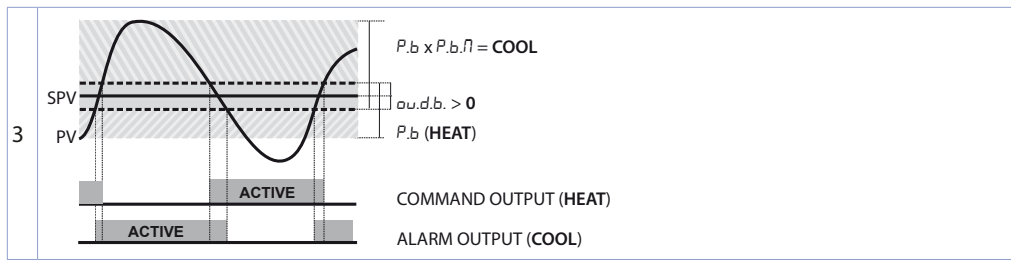

Parameter *cc.t.l* has the same meaning of cycle time for heating action *cc.t.l*.
 Parameter *co.f.l* (Cooling Fluid) pre-selects the proportional band multiplier *Pb.n.l* and the cooling PID cycle time *cc.t.l* according to cooling fluid type:

<i>co.f.l</i>	Cooling fluid type	<i>Pb.n.l</i>	<i>cc.t.l</i>
Air	Air	1.00	10
Oil	Oil	1.25	4
H ₂ O	Water	2.50	2

Once parameter *co.f.l* has been selected, the parameters *Pb.n.l*, *o.d.b.l* and *cc.t.l* can be however modified.

9.10 LATCH ON Function

For use with input *Pb.t.* and with linear input (0..10 V, 0..40 mV, 0/4..20 mA) it is possible to associate start value of the scale (par. 4 *LL.i.1* or par. 21 *LL.i.2*) to the minimum position of the sensor and value of the scale end (par. 5 *UL.i.1* or par. 22 *UL.i.2*) to the maximum position of the sensor (par. 10 *Lt.c.1* or par. 27 *Lt.c.2*) configured as *Stndr*.

It is also possible to fix the point in which the controller will display 0 (however keeping the scale range between *LL.i.1* / *LL.i.2* and *UL.i.1* / *UL.i.2*) using the "virtual zero" option by selecting *u.0.5t.0.* or *u.0.5t.0.* on par. 10 *Lt.c.1* or 27 *Lt.c.2*. Selecting *u.0.5t.0.* the virtual zero must be reset at each switching on; selecting *u.0.5t.0.* the virtual zero will remain fixed once calibrated. To use the LATCH ON function, configure the par. *Lt.c.1* or 27 *Lt.c.2*.

Then refer to the following table for the calibration procedure:

	Press	Display	Do
1	FNC	Exit parameters configuration. Display 2 visualizes writing <i>Lt.c.</i>	Place the sensor on minimum operating value (corresponding to <i>LL.i.1</i> / <i>LL.i.2</i>)
2	✓	Store value on minimum. Display shows <i>LoU</i> .	Place sensor on maximum operating value (corresponding to <i>UL.i.1</i> / <i>UL.i.2</i>).
3	▲	Store value on max. Display shows <i>HiU</i> .	To exit standard proceeding press SEI . For "virtual zero" setting, place the sensor to zero point.
4	FNC	Set virtual zero. Display shows <i>zEr.0.</i> If "Virtual zero at start" is selected, point 4 must be repeated at each starting.	To exit procedure press SEI .

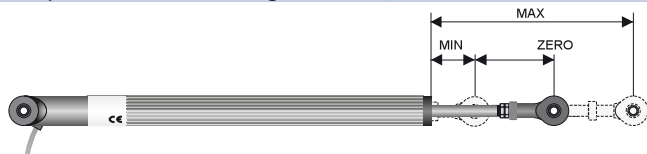

¹ The tuning procedure starts by exiting the configuration after changing the parameter.

9.11 Soft-Start Function

UR4848xA is provided with two types of softstart selectable on parameter 264 *55.t.t.* ("Softstart Type").

- 1 First selection (*GrAd*) enables gradient softstart. At starting the controller reaches setpoint basing on the rising gradient set on parameter 266 *55.Gr.* ("Softstart Gradient") in Unit/hour (ex. °C/h). If parameter 269 *55.t.t.* ("Softstart Time") is different to 0, at starting when the time selected on par. 269 is elapsed, the controller stops to follow the gradient and reaches setpoint with the maximum power.
- 2 Second selection (*PErc*) enables output percental softstart. On par. 268 *55.t.t.* it is possible to set the threshold under which starts the softstart ("Softstart Threshold"). On par. 267 *55.PE.* ("Softstart Percentage") an output percentage is selectable (from 0 to 100), which controller keeps until the process exceeds the threshold set on par. 268 or until the time in minutes set on par. 269 *55.t.t.* ("Softstart Time" word 2084).

If the Sof-Start function is active the automatic/manual Tuning function cannot be activated.

9.12 Pre-Programmed cycle

Pre-programmed cycle function activates by setting *ENAb.* on parameter 263 *Pr.c.t.*

Controller reaches setpoint 1 basing on the gradient set on parameter 266 *55.Gr.*, then it reaches max. power up to setpoint 2. When the process reaches max. power, this setpoint is maintained for the time set on parameter 270 *MA.t.t.*

At expiry, process will reach ambient temperature according to gradient entered on parameter 271 *FR.Gr.*, then command output will be disabled and display will visualize *StoP*.

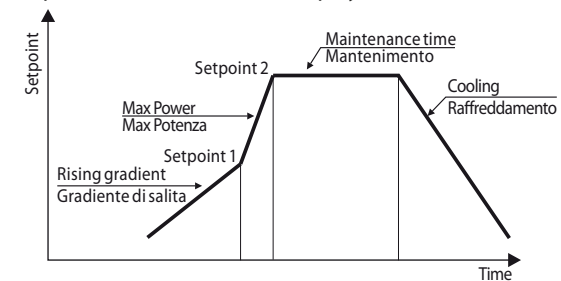

Cycle starts at each activation of the controller, or via digital input if it is enabled for this type of functioning (parameters 231, 239, 247, 255 set as *5t.5t.* or *PuM*).

9.13 Retransmission function on analogue output

If not used as command, the analogue output can be used to retransmit process/ setpoint/ current read by the C.T. input/ output percentage.

Select on parameter 298 *r.t.n.1* ("Retransmission 1") or on parameter 308 *r.t.n.2* ("Retransmission 2") the value to be retransmitted and on parameter 299 *r.t.t.t.* ("Retransmission 1 Type") or on parameter 309 *r.t.t.t.* ("Retransmission 2 Type") the output type.

It is possible also to select on parameters 300 *r.t.u.l.* and 301 *r.t.u.l.* or 310 *r.t.u.l.* and 311 *r.t.u.l.* the input value rescale limites.

10 Serial communication

UR48482A/3A/4A is equipped with RS485 and can receive/broadcast data via serial communication using MODBUS RTU protocol. The device can only be configured as a Slave. This function enables the control of multiple controllers connected to a supervisory system / SCADA.

Each controller responds to a Master query only if the query contains the same address as parameter 318 *SL.Ad.* ("Slave Address").

The addresses permitted range from 1 to 254 and there must not be controllers with the same address on the same line.

Address 255 can be used by the Master to communicate with all the connected equipment (broadcast mode), while with 0 all the devices receive the command, but no response is expected.

The baud rate is selected on parameter 319 *bd.r.t.* ("Baud Rate").

UR48482/3A/4A can introduce a delay (in milliseconds) of the response to the master request. This delay must be set on parameter 321 *SE.dE.* ("Serial Delay").

Each parameter modification is saved by the controller in the EEPROM memory (100000 writing cycles), while the setpoints are saved with a delay of 10 seconds after the last modification.

Changes made to words that are different from those reported in the following table can lead to malfunction.

Modbus RTU protocol features	
Baud-rate	Selectable on parameter 319 <i>bd.r.t.</i> 1200bit/s 28800bit/s 2400bit/s 38400bit/s 4800bit/s 57600bit/s 9600bit/s 115200bit/s 19200bit/s
Format	Selectable on parameter 320 <i>S.P.P.</i> 8N1 8N2 8E1 8E2 8O1 8O2
Supported functions	WORD READING (max 50 word) (0x03, 0x04) SINGLE WORD WRITING (0x06) MULTIPLE WORDS WRITING (max 50 word) (0x10)

Here below a list of all available addresses and supported functions:

RO = Read Only	R/W = Read/Write	WO = Write Only
----------------	------------------	-----------------

Modbus address	Description	Read Write	Reset value
0	Device type	RO	47x
1	Software version	RO	Flash
2	Boot version	RO	Flash
3	Slave Address	RO	Eepr/dip
6	Baud rate	RO	Eepr/dip
50	Slave address automatic learning	WO	-
51	System code comparison for slave address automatic learning	WO	-
500	Loading default values (write 9999)	RW	0
501	Restart UR4848xA (write 9999)	RW	0
502	Setpoint storing delay time	RW	10
503	Parameters storing delay time	RW	1
701	First character of the custom alarm message 1	RW	"u"
...			
723	Last character of the custom alarm message 1	RW	0
751	First character of the custom alarm message 2	RW	"u"
...			

Modbus address	Description	Read Write	Reset value
773	Last character of the custom alarm message 2	RW	0
801	First character of the custom alarm message 3	RW	"u"
...			
823	Last character of the custom alarm message 3	RW	0
851	First character of the custom alarm message 4	RW	"u"
...			
873	Last character of the custom alarm message 4	RW	0
901	First character of the custom alarm message 5	RW	"u"
...			
923	Last character of the custom alarm message 5	RW	0
951	First character of the custom alarm message 6	RW	"u"
...			
973	Last character of the custom alarm message 6	RW	0
1000	AI1 value (degrees with tenth)	RO	-
1001	AI2 value (degrees with tenth)	RO	-
1002	Average between AI1 and AI2 [(AI1 + AI2) / 2] (degrees with tenth)	RO	0
1003	Difference between AI1 and AI2 (AI1 - AI2) (degrees with tenth)	RO	0
1004	Module of the difference between AI1 and AI2 (AI1 - AI2) (degrees with tenth)	RO	0
1005	Sum of AI1 and AI2 (AI1 + AI2) (degrees with tenth)	RO	0
1006	Real setpoint (gradient) of the regulation loop 1	RO	0
1007	Real setpoint (gradient) of the regulation loop 2	RO	0
1008	Alarms status (0=absent, 1=present) Bit0 = Alarm 1 Bit3 = Alarm 4 Bit1 = Alarm 2 Bit4 = Alarm 5 Bit2 = Alarm 3 Bit5 = Alarm 6	RO	0
1009	Error flags 1 Bit0 = AI1 process error (sensor 1) Bit1 = AI2 process error (sensor 2) Bit2 = Cold junction error Bit3 = Safety error Bit4 = Generic error Bit5 = Hardware error Bit6 = Error H.B.A. (partial ropture of the load) Bit7 = Error H.B.A. (SSR in short circuit) Bit8 = Overcurrent error Bit9 = Parameters out of range error Bit10= CPU eeprom writing error Bit11= RFid eeprom writing error Bit12= CPU eeprom reading error Bit13= RFid eeprom reading error Bit14= Eeprom calibrations bench corrupted Bit15= Eeprom constants bench corrupted	RO	0
1010	Error flags 2 Bit0 = Missing calibrations error Bit1 = Eeprom CPU bench parameters corrupted Bit2 = Eeprom CPU setpoint bench corrupted Bit3 = RFid memory not formatted Bit4 = Error AI2 disabled	RO	0
1011	Digital inputs status (0=not active, 1=active) Bit0 = Digital inp. 1 Bit2 = Digital inp. 3 Bit1 = Digital inp. 2 Bit3 = Digital inp. 4	RO	0

Modbus address	Description	Read Write	Reset value
1012	Outputs status (0=off, 1=on) Bit 0 = Q1 Bit 3 = DO1 Bit 1 = Q2 Bit 4 = DO2 Bit 2 = Q3	RO	0
1013	Stato led (0=OFF, 1=ON) Bit 0 = Led UP arrow Bit 6 = Led TUN Bit 1 = Led C1 Bit 7 = Led point time 2 Bit 2 = Led C2 Bit 8 = Led MAN Bit 3 = Led A1 Bit 9 = Led REM Bit 4 = Led A2 Bit 10 = Led DOWN arrow Bit 5 = Led A3 Bit 11 = Led point time 1	RO	0
1014	Key status (0=released, 1=pressed) Bit 0 = Key UP arrow Bit 2 = Key FNC Bit 1 = Key DOWN arrow Bit 3 = Key SET	RO	0
1015	Cold junction temperature (degrees with tenth)	RO	-
1016	Current CT istantaneous (Ampere with tenth)	RO	0
1017	Current CT average (Ampere with tenth)	RO	0
1018	Current CT ON (Ampere with tenth)	RO	0
1019	Current CT OFF (Ampere with tenth)	RO	0
1100	AI1 value with decimal point selection	RO	-
1101	AI2 value with decimal point selection	RO	-
1102	Average between AI1 and AI2 [(AI1 + AI2) /2] with decimal point selection	RO	0
1103	Difference between AI1 and AI2 (AI1 - AI2) with decimal point selection	RO	0
1104	Module of the difference between AI1 and AI2 (AI1 - AI2) with decimal point selection	RO	0
1105	Sum of AI1 and AI2 (AI1 + AI2) with decimal point selection	RO	0
1106	Real setpoint (gradient) of the regulation loop 1 with decimal point selection	RO	0
1107	Real setpoint (gradient) of the regulation loop 2 with decimal point selection	RO	0
1200	Setpoint 1 of regulation loop 1 (degrees with tenth)	R/W	EEPROM
1201	Setpoint 2 of regulation loop 1 (degrees with tenth)	R/W	EEPROM
1202	Setpoint 3 of regulation loop 1 (degrees with tenth)	R/W	EEPROM
1203	Setpoint 4 of regulation loop 1 (degrees with tenth)	R/W	EEPROM
1204	Setpoint 1 of regulation loop 2 (degrees with tenth)	R/W	EEPROM
1205	Setpoint 2 of regulation loop 2 (degrees with tenth)	R/W	EEPROM
1206	Setpoint 3 of regulation loop 2 (degrees with tenth)	R/W	EEPROM
1207	Setpoint 4 of regulation loop 2 (degrees with tenth)	R/W	EEPROM
1208	Alarm 1 setpoint (degrees with tenth) Alarm 1 upper setpoint if Par. 123 $RL.1.F. = R.bRNd$	R/W	EEPROM
1209	Alarm 2 setpoint (degrees with tenth) Alarm 2 upper setpoint if Par. 141 $RL.2.F. = R.bRNd$	R/W	EEPROM
1210	Alarm 3 setpoint (degrees with tenth) Alarm 3 upper setpoint if Par. 159 $RL.3.F. = R.bRNd$	R/W	EEPROM
1211	Alarm 4 setpoint (degrees with tenth) Alarm 4 upper setpoint if Par. 177 $RL.4.F. = R.bRNd$	R/W	EEPROM
1212	Alarm 5 setpoint (degrees with tenth) Alarm 5 upper setpoint if Par. 195 $RL.5.F. = R.bRNd$	R/W	EEPROM
1213	Alarm 6 setpoint (degrees with tenth) Alarm 6 upper setpoint if Par. 213 $RL.6.F. = R.bRNd$	R/W	EEPROM

Modbus address	Description	Read Write	Reset value
1214	Start/Stop 0=controller in STOP 1=controller in START	R/W	0
1215	Hold conversion ON/OFF 0=Hold conversion OFF 1=Hold conversion ON	R/W	0
1216	Tune management for regulation loop 1 With automatic Tune (par. 73 $tun.1 = RuLo$): 0=autotuning function OFF 1=autotuning ON With manual Tune (par. 73 $tun.1 = PRnu. or DncE$): 0=autotuning function OFF 1=autotuning ON With synchronized Tune (par. 73 $tun.1 = SynCH$): 0=autotuning function OFF 1=command output OFF (forces the cooling) 2=command output ON (forces the heating) 3=autotuning ON 4=autotuning ended	R/W	0
1217	Tune management for regulation loop 2 With automatic Tune (par. 98 $tun.2 = RuLo$): 0=autotuning function OFF 1=autotuning ON With manual Tune (par. 98 $tun.2 = PRnu. or DncE$): 0=autotuning function OFF 1=autotuning ON With synchronized Tune (par. 98 $tun.2 = SynCH$): 0=autotuning function OFF 1=command output OFF (forces the cooling) 2=command output ON (forces the heating) 3=autotuning ON 4=autotuning ended	R/W	0
1218	Automatic/manual selection for regulation loop 1 0=automatic; 1=manual	R/W	0
1219	Automatic/manual selection for regulation loop 2 0=automatic; 1=manual	R/W	0
1220	Command output percentage for regulation loop 1 (0-10000) Heating output percentage with regulation 1 in double loop (0-10000)	R/W	0
1221	Command output percentage for regulation loop 1 (0-1000) Heating output percentage with regulation 1 in double loop (0-1000)	R/W	0
1222	Command output percentage for regulation loop 1 (0-100) Heating output percentage with regulation 1 in double loop (0-100)	R/W	0
1223	Cooling output percentage with regulation 1 in double loop (0-10000)	RO	0
1224	Cooling output percentage with regulation 1 in double loop (0-1000)	RO	0
1225	Cooling output percentage with regulation 1 in double loop (0-100)	RO	0
1226	Command output percentage for regulation loop 2 (0-10000) Heating output percentage with regulation 2 in double loop (0-10000)	R/W	0
1227	Command output percentage for regulation loop 2 (0-1000) Heating output percentage with regulation 2 in double loop (0-1000)	R/W	0
1228	Command output percentage for regulation loop 2 (0-100) Heating output percentage with regulation 2 in double loop (0-100)	R/W	0

Modbus address	Description	Read Write	Reset value
1229	Cooling output percentage with regulation 2 in double loop (0-10000)	RO	0
1230	Cooling output percentage with regulation 2 in double loop (0-1000)	RO	0
1231	Cooling output percentage with regulation 2 in double loop (0-100)	RO	0
1232	Command output manual reset for regulation loop 1: write 0 to reset the command output. In reading 0=reset not allowed, 1=reset allowed	R/W	0
1233	Alarms manual reset: write 0 to reset all alarms. In reading 0=reset not allowed, 1=reset allowed Bit0 = Alarm 1 Bit3 = Alarm 4 Bit1 = Alarm 2 Bit4 = Alarm 5 Bit2 = Alarm 3 Bit5 = Alarm 6	R/W	0
1234	Command output manual reset for regulation loop 2: write 0 to reset the command output. In reading 0=reset not allowed, 1=reset allowed	R/W	0
1235	Alarm 1 remote stauts (0=absent, 1=present)	R/W	0
1236	Alarm 2 remote stauts (0=absent, 1=present)	R/W	0
1237	Alarm 3 remote stauts (0=absent, 1=present)	R/W	0
1238	Alarm 4 remote stauts (0=absent, 1=present)	R/W	0
1239	Alarm 5 remote stauts (0=absent, 1=present)	R/W	0
1240	Alarm 6 remote stauts (0=absent, 1=present)	R/W	0
1241	Value AO1 by serial (Par. 298 $r_{tP1} = P_{d.bu5}$)	R/W	0
1242	Value AO2 by serial (Par. 308 $r_{tP2} = P_{d.bu5}$)	R/W	0
1243	Tara di zero AI1 (1=tare; 2=reset tare)	R/W	0
1244	Tare of zero AI2 (1=tare; 2=reset tare)	R/W	0
1245	Tare of zero average between AI1 and AI2 $[(AI1 + AI2) / 2]$ (1=tare; 2=reset tare)	R/W	0
1246	Tare of zero difference between AI1 and AI2 $(AI1 - AI2)$ (1=tare; 2=reset tare)	R/W	0
1247	Tare of zero module of the difference between AI1 and AI2 $(AI1 - AI2)$ (1=tare; 2=reset tare)	R/W	0
1248	Tare of zero sum of AI1 and AI2 $(AI1 + AI2)$ (1=tare; 2=reset tare)	R/W	0
1249	Value of remote setpoint by command 1 serial	R/W	0
1250	Value of remote setpoint by command 2 serial	R/W	0
1251	Alarm 1 lower setpoint if Par. 123 $RL.1.F. = R.bRNd$ (degrees with tenth)	R/W	EEPROM
1252	Alarm 2 lower setpoint if Par. 141 $RL.2.F. = R.bRNd$ (degrees with tenth)	R/W	EEPROM
1253	Alarm 3 lower setpoint if Par. 159 $RL.3.F. = R.bRNd$ (degrees with tenth)	R/W	EEPROM
1254	Alarm 4 lower setpoint if 177 $RL.4.F. = R.bRNd$ (degrees with tenth)	R/W	EEPROM
1255	Alarm 5 lower setpoint if Par. 195 $RL.5.F. = R.bRNd$ (degrees with tenth)	R/W	EEPROM
1256	Alarm 6 lower setpoint if Par. 213 $RL.6.F. = R.bRNd$ (degrees with tenth)	R/W	EEPROM
1300	Setpoint 1 of regulation loop 1, with decimal point selection	R/W	EEPROM
1301	Setpoint 2 of regulation loop 1, with decimal point selection	R/W	EEPROM
1302	Setpoint 3 of regulation loop 1, with decimal point selection	R/W	EEPROM
1303	Setpoint 4 of regulation loop 1, with decimal point selection	R/W	EEPROM
1304	Setpoint 1 of regulation loop 2, with decimal point selection	R/W	EEPROM
1305	Setpoint 2 of regulation loop 2, with decimal point selection	R/W	EEPROM
1306	Setpoint 3 of regulation loop 2, with decimal point selection	R/W	EEPROM
1307	Setpoint 4 of regulation loop 2, with decimal point selection	R/W	EEPROM
1308	Alarm 1 setpoint, with decimal point selection Alarm 1 upper setpoint if Par. 123 $RL.1.F. = R.bRNd$	R/W	EEPROM

Modbus address	Description	Read Write	Reset value
1309	Alarm 2 setpoint, with decimal point selection Alarm 2 upper setpoint if Par. 141 $RL.2.F. = R.bRNd$	R/W	EEPROM
1310	Alarm 3 setpoint, with decimal point selection Alarm 3 upper setpoint if Par. 159 $RL.3.F. = R.bRNd$	R/W	EEPROM
1311	Alarm 4 setpoint, with decimal point selection Alarm 4 upper setpoint if Par. 177 $RL.4.F. = R.bRNd$	R/W	EEPROM
1312	Alarm 5 setpoint, with decimal point selection Alarm 5 upper setpoint if Par. 195 $RL.5.F. = R.bRNd$	R/W	EEPROM
1313	Alarm 6 setpoint, with decimal point selection Alarm 6 upper setpoint if Par. 213 $RL.6.F. = R.bRNd$	R/W	EEPROM
1351	Alarm 1 lower setpoint if Par. 123 $RL.1.F. = R.bRNd$, with decimal point selection	R/W	EEPROM
1352	Alarm 2 lower setpoint if Par. 141 $RL.2.F. = R.bRNd$, with decimal point selection	R/W	EEPROM
1353	Alarm 3 lower setpoint if Par. 159 $RL.3.F. = R.bRNd$, with decimal point selection	R/W	EEPROM
1354	Alarm 4 lower setpoint if Par. 177 $RL.4.F. = R.bRNd$, with decimal point selection	R/W	EEPROM
1355	Alarm 5 lower setpoint if Par. 195 $RL.5.F. = R.bRNd$, with decimal point selection	R/W	EEPROM
1356	Alarm 6 lower setpoint if Par. 213 $RL.6.F. = R.bRNd$, with decimal point selection	R/W	EEPROM
2001	Parameter 1	R/W	EEPROM
2002	Parameter 2	R/W	EEPROM
...	Parameter ...	R/W	EEPROM
2366	Parameter 366	R/W	EEPROM

11 Reading and configuration through NFC

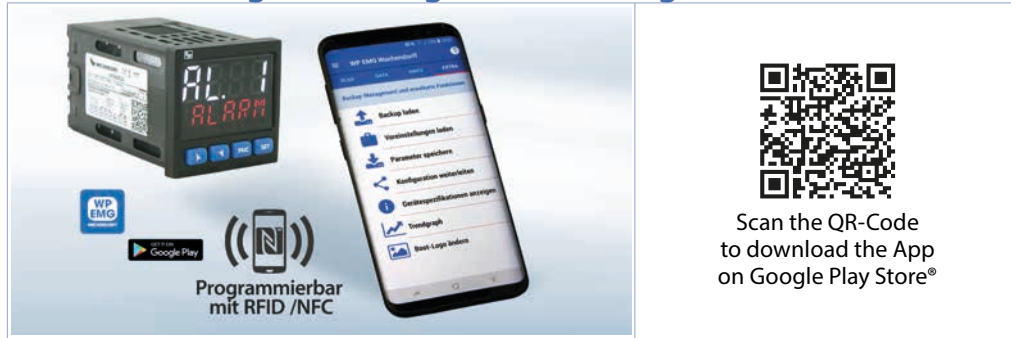

The controller UR4848xA is supported by the App Wachendorff EMG: using an ANDROID smartphone with NFC connection it is possible to program the device without using a dedicated equipment. The App allows to read, set and backup all parameters which are stored into the internal memory of Wachendorff devices.

Procedure:

- Identify the position of the NFC antenna on the smartphone (usually central, behind the back cover) or to one of the sides in case of metal chassis. The UR4848xA's antenna is placed on the frontal panel, under the function keys.
- Make sure that the NFC sensor of the phone is enabled or that there are no metal materials between the phone and the device (ex. aluminium cover or with magnetic stand)
- It is useful to enable the system sounds on the smartphone, as the notification sound confirms that the device has correctly been detected.

The App interface is provided with four tabs: SCAN, DATA, WRITE, EXTRA.

Select the first tab "SCAN" to read data stored into the internal memory of the device; place the smartphone in contact with the controller frontal panel, making sure that the phone's antenna matched with that of the controller.

Once detected the device, the App emits a notification sounds and proceeds with the model identification and the reading of the parameters.

The graphic interface shows the advancement and switches to the second tab "DATA". It is now possible to move the smartphone away from the controller to make the required modifications more easily.

The device parameters are divided into collapsible groups and are displayed with name, current value and reference index to the manual.

Click on a row to open the setting screen of the related parameter with the detailed view of available options (in case of multiple choice parameters) or of the minimum/maximum/decimals limits (for numeric parameters), included the text description (as per section n. 11 of the user manual). Once selected the chosen value, the related row will be updated and underlined into the tab "DATA" (hold down the line to cancel modifications).

To download the new configuration on your device, select the third tab "WRITE", place again the smartphone in contact with the controller and wait for the notification.

The UR4848xA will show a restart request, necessary to update the configuration with the new written modifications; if it does not restart, the UR4848xA will continue to work with the previous configuration.

In addition to the classic operation of parameters reading->modification->writing, Wachendorff EMG is provided with additional functions which can be accessed by the tab "EXTRA", as save parameters / e-mail loaded values/ restore default values.

12 Access configuration

	Press	Display	Do
1	FNC for 3 sec.	Display 1 shows <i>PASS.</i> , while display 2 shows <i>0000</i> with the 1st digit flashing.	
2	▲ ▼	Modify flashing digit and move to next digit with SET .	Enter password <i>1234</i> .
3	FNC to confirm	Display 1 shows the first parameters group, display 2 shows the description.	
4	▲ or ▼	Scroll parameters groups.	
5	SET to confirm	Display 1 shows the first parameter of the group and display 2 shows its value.	Press FNC to exit configuration.
6	▲ or ▼	Scroll parameters.	
7	SET to confirm	Allows parameter modification (display 2 flashes)	
8	▲ or ▼	Increases or decreases visualized value	Introduce new data
9	SET	Confirms and stores the new value. If the value is different from default values, the arrow keys light on.	
10	FNC	Backs to parameter groups selection (see point 3).	Press again FNC to exit configuration

12.1 Loading default values

This procedure allows to restore factory settings of the device.

	Press	Display	Do
1	FNC for 3 sec	Display 1 shows <i>PASS.</i> , while display 2 shows <i>0000</i> with the 1st digit flashing.	
2	▲ or ▼	Modify the flashing digit and move to the next one pressing SET .	Enter password <i>9999</i> .
3	FNC to confirm	The device loads default settings and restarts.	

12.2 Parameters list functioning

The controller UR4848xA integrates many features that make the configuration parameters list very long. To make it more functional, the parameters list is dynamics and it changes as the user enables / disables the functions. Practically, using a specific function that occupies a given input (or output), the parameters referred to other functions of that resource are hidden to the user making the parameters list more concise.

To simplify the reading/interpretation of the parameters, pressing **SET** it is possible to visualize a brief description of the selected parameter.

Finally, keeping pressed **FNC**, it is possible to move from the mnemonic visualization of the parameter to the numeric one, and vice versa. Ex. The first parameter can be displayed as *SEn.1* (mnemonic visualization) or as *PO01* (numeric visualization).

Set the product parameters so that they are suitable for the system to be controlled. If they are not suitable, unexpected operations may occasionally cause materials damage or accidents.

13 Table of Configuration Parameters

GROUP A - *R. in. I* - Analogue input 1

1 *SEN.I* Sensor AI1

Analogue input configuration / sensor AI1 selection

<i>EC.K</i>	Tc-K	-260° C..1360° C. (Default)
<i>EC.S</i>	Tc-S	-40° C..1760° C
<i>EC.R</i>	Tc-R	-40° C..1760° C
<i>EC.J</i>	Tc-J	-200° C..1200° C
<i>EC.T</i>	Tc-T	-260° C..400° C
<i>EC.E</i>	Tc-E	-260° C..980° C
<i>EC.N</i>	Tc-N	-260° C..1280° C
<i>EC.b</i>	Tc-B	100° C..1820° C
<i>PE100</i>	Pt100	-200° C..600° C
<i>Ni100</i>	Ni100	-60° C..180° C
<i>NEC1</i>	NTC 10K β3435K	-40° C..125° C
<i>PEC</i>	PTC 1K	-50° C..150° C
<i>PE500</i>	Pt500	-200° C..600° C
<i>PE1K</i>	Pt1000	-200° C..600° C
<i>0-1</i>	0..1 V	
<i>0-5</i>	0..5 V	
<i>0-10</i>	0..10 V	
<i>0-20</i>	0..20 mA	
<i>4-20</i>	4..20 mA	
<i>0-60</i>	0..60 mV	
<i>Pot.</i>	Potentiometer (set the value on parameter 6)	
<i>Ni120</i>	Ni120	-60° C..240° C
<i>NEC2</i>	NTC 10K β3694K	-40° C..150° C
<i>NEC3</i>	NTC 2252 β3976K	-40° C..150° C

2 *d.P. I* Decimal Point 1

Select number of displayed decimal points for AI1

0	Default
<i>0.0</i>	1 decimal
<i>0.00</i>	2 decimals
<i>0.000</i>	3 decimals

3 *dEGr.* Degree

<i>°C</i>	Celsius (Default)
<i>°F</i>	Fahrenheit
<i>K</i>	Kelvin

4 *LL.I* Lower Linear Input AI1

AI1 lower limit only for linear signals. Ex.: with input 4..20 mA this parameter takes value associated to 4 mA. The value may be greater than the one entered on the next parameter.
-9999..+30000 [digit^[p.7]] **Default:** 0.

5 *UL.I* Upper Linear Input AI1

AI1 upper limit only for linear signals Ex: with input 4..20 mA this parameter takes value associated to 20 mA. The value may be lower than the one entered on the previous parameter.
-9999..+30000 [digit^[p.7]] **Default:** 1000

6 *P.UR.I* Potentiometer Value AI1

Selects the value of the potentiometer connected on AI1
1..150 kohm. Default: 10kohm

7 *LO.L* Linear Input over Limits AI1

If AI1 is a linear input, allows to the process to overpass the limits (Par. 3 and 4).

<i>d.SRb.</i>	Disabled (Default)
<i>ENRb.</i>	Enabled

8 *o.c.R.I* Offset Calibration AI1

AI1 Offset calibration. Value added/subtracted to the process value (ex: usually correcting the ambient temperature value).
-9999..+9999 [digit^[p.7]] (degrees.tenths for temperature sensors). **Default** 0.

9 *G.c.R.I* Gain Calibration AI1

Value multiplied to the process value to calibrate the working point. Ex: to correct the range from 0..1000°C showing 0..1010°C, set the parameter to -1.0
-100.0%...+100.0%, **Default:** 0.0.

10 *LEc.I* Latch-On AI1

Automatic setting of limits for AI1 linear input

<i>d.SRb.</i>	Disabled (Default)
<i>SENRd</i>	Standard
<i>V.D.SLo.</i>	Virtual Zero Stored
<i>V.D.E.oN.</i>	Virtual Zero at start

11 *c.F.L* Conversion Filter AI1

ADC Filter: Number of sensor readings to calculate mean that defines process value. **NB:** When readings increase, control loop speed slows down. 1...15. **(Default:** 10)

12 *c.Fr.I* Conversion Frequency AI1

Sampling frequency of digital / analogue converter for AI1. Increasing the conversion speed will slow down reading stability (example: for fast transients, as the pressure, it is advisable to increase sampling frequency)

<i>4.17.HZ</i>	4.17 Hz (Min. conversion speed)
<i>6.25HZ</i>	6.25 Hz
<i>8.33HZ</i>	8.33 Hz
<i>10.0HZ</i>	10.0 Hz
<i>12.5HZ</i>	12.5 Hz
<i>16.7HZ</i>	16.7 Hz (Default) Ideal for filtering noises 50 / 60 Hz
<i>19.6HZ</i>	19.6 Hz
<i>33.2HZ</i>	33.2 Hz
<i>39.0HZ</i>	39.0 Hz
<i>50.0HZ</i>	50.0 Hz
<i>62.0HZ</i>	62.0 Hz
<i>123HZ</i>	123 Hz
<i>242HZ</i>	242 Hz
<i>470HZ</i>	470 Hz (Max. speed conversion)

13÷17 Reserved Parameters - Group A

Reserved parameters - Group A

GROUP B - P_L - Analogue input 2 (only on UR48483A/4A)

18 SE_{AI2} Sensor AI2

Analogue input configuration / sensor AI2 selection

d_{5RB}	Disabled	Disabled. (Default)
$t_{c, K}$	Tc-K	-260° C..1360° C.
$t_{c, S}$	Tc-S	-40° C..1760° C
$t_{c, R}$	Tc-R	-40° C..1760° C
$t_{c, J}$	Tc-J	-200° C..1200° C
$t_{c, t}$	Tc-T	-260° C..400° C
$t_{c, E}$	Tc-E	-260° C..980° C
$t_{c, N}$	Tc-N	-260° C..1280° C
$t_{c, b}$	Tc-B	100° C..1820° C
$Pt100$	Pt100	-200° C..600° C
$Ni100$	Ni100	-60° C..180° C
$Ntc 1$	NTC 10K β 3435K	-40° C..125° C
Ptc	PTC 1K	-50° C..150° C
$Pt500$	Pt500	-200° C..600° C
$Pt1K$	Pt1000	-200° C..600° C
$0-1$	0..1 V	
$0-5$	0..5 V	
$0-10$	0..10 V	
$0-20$	0..20 mA	
$4-20$	4..20 mA	
$0-60$	0..60 mV	
Pot	Potentiometer (set the value on parameter 23)	
$Ni120$	Ni120	-60° C..240° C
$Ntc 2$	NTC 10K β 3694K	-40° C..150° C
$Ntc 3$	NTC 2252 β 3976K	-40° C..150° C

19 $d.P. 2$ Decimal Point 2

Select number of displayed decimal points for AI 2

0	Default
0.0	1 decimal
0.00	2 decimals
0.000	3 decimals

20 rES Reserved

Reserved parameter.

21 LL_{i2} Lower Linear Input AI2

AI2 lower limit only for linear signals. Ex.: with input 4..20 mA this parameter takes value associated to 4 mA. The value may be greater than the one entered on the next parameter.

-9999..+30000 [digit^[p.7]] **Default:** 0.

22 UL_{i2} Upper Linear Input AI2

AI2 upper limit only for linear signals Ex: with input 4..20 mA this parameter takes value associated to 20 mA. The value may be lower than the one entered on the previous parameter..

-9999..+30000 [digit^[p.7]] **Default:**1000

23 P_{AI2} Potentiometer Value AI2

Selects the value of the potentiometer connected on AI2

1..150 kohm. **Default:** 10kohm

24 LO_{L2} Linear Input over Limits AI2

If AI2 is a linear input, allows to the process to overpass the limits (Par. 18 and 19).

d_{5RB} . Disabled (**Default**)

EN_{RB} . Enabled

25 $o.c_{AI2}$ Offset Calibration AI2

AI2 Offset calibration. Value added/subtracted to the process value (ex: usually correcting the ambient temperature value).

-9999..+9999 [digit^[p.7]] (degrees.tenths for temperature sensors). **Default** 0.

26 G_{AI2} Gain Calibration AI2

Value multiplied to the process value to calibrate the working point. Ex: to correct the range from 0..1000°C showing 0..1010°C, set the parameter to -1.0

-100.0%...+100.0%, **Default:** 0.0.

27 LE_{AI2} Latch-On AI2

Automatic setting of limits for AI2 linear input

d_{5RB} . Disabled (**Default**)

SE_{NRD} Standard

$V.D.5Eo$. Virtual Zero Stored

$V.D.E.oH$ Virtual Zero at start

28 c_{FL2} Conversion Filter AI2

ADC Filter: Number of sensor readings to calculate mean that defines process value.

NB: When readings increase, control loop speed slows down.

1..15. (**Default:** 10)

29 c_{Fr2} Conversion Frequency AI2

Sampling frequency of digital / analogue converter for AI2.

Increasing the conversion speed will slow down reading stability

(example: for fast transients, as the pressure, it is advisable to increase sampling frequency).

$4.17.Hz$ 4.17 Hz (Min. conversion speed)

$6.25Hz$ 6.25 Hz

$8.33Hz$ 8.33 Hz

$10.0Hz$ 10.0 Hz

$12.5Hz$ 12.5 Hz

$16.7Hz$ 16.7 Hz (**Default**) Ideal for filtering noises 50 / 60 Hz

$19.6Hz$ 19.6 Hz

$33.2Hz$ 33.2 Hz

$39.0Hz$ 39.0 Hz

$50.0Hz$ 50.0 Hz

$62.0Hz$ 62.0 Hz

$123Hz$ 123 Hz

$242Hz$ 242 Hz

$470Hz$ 470 Hz (Max. speed conversion)

30÷34 Reserved Parameters - Group B

Reserved parameters - Group B

GROUP C - *c.f.d.l* - Outputs and regulation Process 1

35 *c.o.u.1* Command Output 1

Selects the command output related to the process1 and the outputs related to the alarms.

- c. a2* Command on relay output Q2.
- c. a1* Command on relay output Q1. **(Default)**
- c. 55P* Command on digital output
- c. VRL* Sevo-valve command with open loop
- c. 0-10* Command 0-10 V on analogue output AO1.
- c. 4-20* Command 4-20 mA on analogue output AO1.
- 0.10.5.P.* Command 0-10 V on analogue output AO1 with split-range function: the analogue output sets the cooling action from 0 to 5V and heating action from 5 to 10V.
- 4.20.5.P.* Command 4-20 mA on analogue output AO1 with split-range function: the analogue output sets the cooling action from 4 to 12mA and heating action from 12 to 20mA.

UR48481A and UR48482A

Command	AL. 1	AL. 2	AL. 3	AL. 4
<i>c. a2</i> Q2	Q1	DO1	DO2	AO1
<i>c. a1</i> Q1	Q2	DO1	DO2	AO1
<i>c. 55P</i> DO1	Q1	Q2	DO2	AO1
<i>c. VRL</i> Q1(open) Q2(close)	DO1	DO2	AO1	-
<i>c. 0-10</i> AO1 (0..10 V)	Q1	Q2	DO1	DO2
<i>c. 4-20</i> AO1 (4..20 mA)	Q1	Q2	DO1	DO2

UR48485A

Command	AL. 1	AL. 2	AL. 3	AL. 4	AL. 5
<i>c. a2</i> Q2	Q1	Q3	DO1	DO2	AO1
<i>c. a1</i> Q1	Q2	Q3	DO1	DO2	AO1
<i>c. 55P</i> DO1	Q1	Q2	Q3	DO2	AO1
<i>c. VRL</i> Q1(open) Q2(close)	Q3	DO1	DO2	AO1	-
<i>c. 0-10</i> AO1 (0..10 V)	Q1	Q2	Q3	DO1	DO2
<i>c. 4-20</i> AO1 (4..20 mA)	Q1	Q2	Q3	DO1	DO2

UR48483A and UR48484A

Command	AL. 1	AL. 2	AL. 3	AL. 4	AL. 5	AL. 6
<i>c. a2</i> Q2	Q1	Q3	DO1	DO2	AO1	AO2
<i>c. a1</i> Q1	Q2	Q3	DO1	DO2	AO1	AO2
<i>c. 55P</i> DO1	Q1	Q2	Q3	DO2	AO1	AO2
<i>c. VRL</i> Q1(open) Q2(close)	Q3	DO1	DO2	AO1	AO2	-
<i>c. 0-10</i> AO1 (0..10 V)	Q1	Q2	Q3	DO1	DO2	AO2
<i>c. 4-20</i> AO1 (4..20 mA)	Q1	Q2	Q3	DO1	DO2	AO2

NB: if an output is used for functions other than alarms (for example retransmission or command n° 2), this resource will no longer be available as an alarm and the related group will be hidden from the parameter list. The correspondence of the functions/outputs remains however that indicated in the tables above.

36 *c.Pr.1* Command Process 1 (only on UR48483A/4A)

Selects process value related to process 1 and to command output 1.

- R.N.1* Value read on input AI1. **(Default)**
- R.N.2* Value read on input AI2.
- MER#* Arithmetic average of the value read on inputs AI1 and AI2 $[(AI1+AI2)/2]$.
- d.FF.* Difference of the values read on inputs AI1 and AI2 $(AI1-AI2)$.
- Rb.d.F.* Module of the difference of the values read on inputs AI1 and AI2 $(|AI1-AI2|)$.
- Sum* Sum of values read on inputs AI1 and AI2 $(AI1+AI2)$.

37 *r.ES.* Reserved

Reserved parameter.

38 *R.c.E.1* Action type 1

Action type to control process 1.

HE#E Heating (N.A.) **(Default)**

COOL Cooling (N.C.)

39 *c.HY.1* Command Hysteresis 1

Hysteresis to control process 1 in ON/OFF.

-9999..+9999 [digit^{1p.71}] (degrees.tenths for temperature sensors). **Default** 0.2.

40 *L.L.S.1* Lower Limit Setpoint 1

Lower limit setpoint selectable for command setpoint 1.

-9999..+30000 [digit^{1p.71}] (degrees.tenths for temperature sensors). **Default** 0.

41 *u.L.S.1* Upper Limit Setpoint 1

Upper limit setpoint selectable for command setpoint 1.

-9999..+30000 [digit^{1p.71}] (degrees for temperature sensors). **Default** 1750.

42 *c.r.E.1* Command Reset 1

Type of reset for command contact 1 (always automatic in P.I.D. functioning)

R. RES. Automatic Reset **(Default)**

M. RES. Manual Reset (by keyboard or by digital input)

M.RES.5. Manual Reset Stored (keeps relay status also after an eventual power failure)

R.RES.E. Automatic reset with timed activation. The command remains active for the time set on the parameter 45 *c.dE.t.*, even if the conditions generating it are missing. To be able to act again, the conditions for activating the command must disappear.

43 *c.S.E.1* Command State Error 1

State of contact for command 1 output in case of error.

If the command output 1 (Par. 35 *c.o.u.1*) is relay or valve:

aPEN Contact or valve open. **Default**

cLoSE Contact or valve closed.

If the command output 1 is digital output (SSR):

aFF Digital output OFF. **Default**

a# Digital output ON.

If the command output 1 is 0-10V:

0 V 0 V. **Default**

10 V 10 V.

If the command output 1 is 0-20 mA or 4-20 mA:

0 mA 0 mA. **Default**

4 mA 4 mA.

20 mA 20 mA.

21.5mA 21.5 mA.

44 *c.L.d.1* Command Led 1

Defines led C1 state corresponding to the relevant output. If the valve command is selected, this parameter is not managed.

a.c. ON with open contact or SSR switched off. If command AO1, ON with output 0%, OFF if 100% and flashing between 1% and 99%.

c.c. ON with closed contact or SSR switched on. If command AO1 ON with output 100%, OFF if 0% and flashing between 1% and 99%. **(Default)**

45 *c.dE.1* Command Delay 1

Command 1 delay (only in ON / OFF functioning).

-60:00..60:00 mm:ss. **Default:** 00:00.

Negative: delay when turning off output.

Positive: delay when turning on output.

46 **c.S.P.1** **Command Setpoint Protection 1**

Allows or not to modify command setpoint 1 value
FREE Modification allowed (**Default**)
Lock Protected

47 **v.R.L.1** **Valve Time 1**

Valve time related to command 1 (declared by the manufacturer of the valve)
1...300 seconds. **Default:** 60.

48 **R.A.R.1** **Automatic / Manual 1**

Enables the automatic/manual selection for command 1
d.S.R.b. Disabled (**Default**)
EN.R.b. Enabled
EN.Sto. Enabled with memory

49 **in.S.** **Initial State**

Choose the state of the controller when turning it on. This only works on the RS485 version or by enabling the Start/Stop from digital input or **SI** button.
START Start (**Default**)
Stop Stop
StoPE. Stored. State of Start/Stop prior to switching off.

50÷53 **Reserved Parameters - Group C**

Reserved parameters - Group C

GROUP D - **c.nd.2** - Outputs and regul. Process 2 (only on UR48483A/4A)

54 **c.o.u.2** **Command Output 2**

Selects the command output related to the process 2
NB: refer to the function/output table of parameter 35 **c.o.u.1** to check which resources will remain available after changing this parameter (eg: setting **c.o.u.2** as **c.SSR**, it will no longer be possible to enable the alarm associated with the DO2 output).

d.S.R.b. Command disabled. (**Default**)
c. o3 Command on relay output Q3
c. SSR Command on digital output DO2
c. VAL Sevo-valve command with open loop on DO1 (open) and DO2 (close)
c.0.-10 Command 0-10 V on analogue output AO2
c.4-20 Command 4-20 mA on analogue output AO2
0.10.5.R. Command 0-10 V on analogue output AO2 with split-range function: the analogue output sets the cooling action from 0 to 5V and heating action from 5 to 10V.
4.20.5.R. Command 4-20 mA on analogue output AO2 with split-range function: the analogue output sets the cooling action from 4 to 12mA and heating action from 12 to 20mA.

55 **c.Pr.2** **Command Process 2**

Selects process value related to process 2 and to command output 2.
R.in.1 Value read on input AI1. (**Default**)
R.in.2 Value read on input AI2.
MERN Arithmetic average of the value read on inputs AI1 and AI2 $[(AI1-AI2)/2]$.
d.dFF. Difference of the values read on inputs AI1 and AI2 $(AI1-AI2)$.
Rb.d.dF. Module of the difference of the values read on inputs AI1 and AI2 $(|AI1-AI2|)$.
Sum Sum of values read on inputs AI1 and AI2 $(AI1+AI2)$.

56 **r.EN.S.** **Remote Setpoint**

Enables remote setpoint. The control setpoint is sent by another device and is received by a second analogue input (it is necessary to select on parameter **c.Pr.2** the selections **R.i. 1** or **R.i. 2**) or through serial.
d.S.R.b. Disabled. (**Default**)
EN.R.b. Enables remote setpoint by process 2. Remote/local selection can be done by digital input.
EN.Sto. Remote setpoint by process 2, Remote/local selection only by keyboard (not allowed by digital input)
EN.SER. Enables remote setpoint by serial input. Remote/local selection can be done by digital input.
EN.SE.L. Remote setpoint by serial, Remote/local selection only by keyboard (not allowed by digital input).
c.nd. 1 The reference setpoint of command 2 is the same of command 1.

57 **R.c.L.2** **Action type 2**

Action type to control process 2.
HEAT Heating (N.A.) (**Default**)
cool Cooling (N.C.)

58 **c.H.2** **Command Hysteresis 2**

Hysteresis to control process 2 in ON/OFF.
-9999..+9999 [digit^{1p.7}] (degrees.tenths for temperature sensors). **Default** 0.2.

59 **L.L.S.2** **Lower Limit Setpoint 2**

Lower limit setpoint selectable for command setpoint 2.
-9999..+30000 [digit^{1p.7}] (degrees for temperature sensors). **Default** 0.

60 **u.L.S.2** **Upper Limit Setpoint 2**

Upper limit setpoint selectable for command setpoint 2.
-9999..+30000 [digit^{1p.7}] (degrees for temperature sensors). **Default** 1750.

61 **c.r.E.2** **Command Reset 2**

Type of reset for command contact 2 (always automatic in P.I.D. functioning)
R. RES. Automatic Reset (**Default**)
M. RES. Manual Reset (by keyboard or by digital input)
M.RES.S. Manual Reset Stored (keeps relay status also after an eventual power failure)
R.RES.L. Automatic reset with timed activation. The command remains active for the time set on the parameter 64 **c.de.2.**, even if the conditions generating it are missing. To be able to act again, the conditions for activating the command must disappear.

62 **c.S.E.2** **Command State Error 2**

State of contact for command 2 output in case of error.
If the command output 2 (Par. 54 **c.o.u.2) is relay or valve:**

oPEN Contact or valve open. **Default**
cLoSE Contact or valve closed.

If the command output 2 is digital output (SSR):

oFF Digital output OFF. **Default**
oM Digital output ON.

If the command output 2 is 0-10V:

0 V 0 V. **Default**
10 V 10 V.

If the command output 2 is 0-20 mA or 4-20 mA:

0 mA 0 mA. **Default**
4 mA 4 mA.

20 MR 20 mA.
21.5MR 21.5 mA.

63 c.Ld.2 Command Led 2
Defines led **C** state corresponding to the relevant output. If the valve command is selected, this parameter is not managed.

o.c. ON with open contact or SSR switched off. If command AO2, ON with output 0%, OFF if 100% and flashing between 1% and 99%.
c.c. ON with closed contact or SSR switched on. If command AO2 ON with output 100%, OFF if 0% and flashing between 1% and 99%. **(Default)**

64 c.dE.2 Command Delay 2
Command 2 delay (only in ON / OFF functioning).

-60:00..60:00 mm:ss. **Default:** 00:00.
Negative: delay when turning off output.
Positive: delay when turning on output.

65 c.S.P.2 Command Setpoint Protection 2

Allows or not to modify command setpoint 2 value
FREE Modification allowed **(Default)**
Lock Protected

66 v.R.t.2 Valve Time 2

Valve time related to command 2 (declared by the manufacturer of the valve)
1...300 seconds. **Default:** 60.

67 A.M.R.2 Automatic / Manual 2

Enables the automatic/manual selection for command 2
d.SRb. Disabled **(Default)**
EMRb. Enabled
EM.5to. Enabled with memory

68÷72 Reserved Parameters - Group D

Reserved parameters - Group D

GROUP E - r.EG.1 - Autotuning and PID 1

73 t.un.1 Tune 1

Selects autotuning type for command 1
d.SRb. Disabled. If proportional band and integral time parameters are set to zero, the regulation is ON/OFF type. **(Default)**
Ruto Automatic (Automatic P.I.D. parameters calculation)
MRnu. Manual (launch by keyboards or by digital input)
oMzE Once (P.I.D. parameters calculation only at first start)
SYncH. Synchronized (Autotuning managed by serial)

74 S.d.t.1 Setpoint Deviation Tune 1

Selects deviation from command setpoint 1 as threshold used by autotuning to calculate P.I.D. parameters
0-10000 [digit^{1p.71}] (degrees.tenths for temp. sensors). **Default:** 30.0.

75 P.b. 1 Proportional Band 1

Proportional band or process 1 P.I.D. regulation (Process inertia).
0 ON / OFF if t.i. equal to 0 **(Default)**
1...10000 [digit^{1p.71}] (degrees.tenths for temp. sensors).

76 i.t. 1 Integral Time 1

Integral time for process 1 P.I.D. regulation (process inertia duration).
0.0...2000.0 secondi (0.0 = integral disabled), **Default** 0.0

77 d.t. 1 Derivative Time 1

Derivative time for process 1 P.I.D. regulation (Normally ¼ of integral time).
0.0...1000.0 secondi (0.0 = derivative disabled), **Default** 0

78 d.b. 1 Dead Band 1

Dead band of process 1 P.I.D..
0...10000 [digit^{1p.71}] (degrees.tenths for temp. sensors) **(Default:** 0)

79 P.b.c.1 Proportional Band Centered 1

Defines if the proportional band 1 must be centered or not on the setpoint. In double loop functioning (heating/cooling), always disabled.
d.SRb. Disabled. Band under (heating) or over (cooling) **(Default)**
EMRb. Centered band

80 o.o.S.1 Off Over Setpoint 1

In P.I.D. enables the command output 1 switching off, when a certain threshold is exceeded (setpoint + Par.81)
d.SRb. Disabled **(Default)**
EMRb. Enabled

81 o.d.t.1 Off Deviation Threshold 1

Selects deviation from command setpoint 1, to calculate the intervention threshold of "Off Over Setpoint 1" function.
-9999...+9999 [digit^{1p.71}] (degrees.tenths for temp. sensors) **(Default:** 0)

82 c.t. 1 Cycle Time 1

Cycle time for P.I.D. regulation of process 1 (for P.I.D. on remote control switch 15 s; for PID on SSR 2s). For valve refer to parameter 47 v.R.t.1
1-300 seconds **(Default:**15 s)

83 c.o.F.1 Cooling Fluid 1

Type of refrigerant fluid for heating / cooling P.I.D. for process 1. Enable the cooling output on parameter AL.1... AL.6.
RiP Air **(Default)**
o.L Oil
WRLEP Water

84 P.b.M.1 Proportional Band Multiplier 1

Proportional band multiplier for heating/cooling P.I.D. for process 1. Proportional band for cooling action is given by parameter P.b. 1 multiplied for this value
1.00...5.00. **Default:** 1.00

85 o.d.b.1 Overlap / Dead Band 1

Dead band combination for heating / cooling P.I.D. (double action) for process 1.
-20.0%...50.0%
Negative: Dead band.
Positive: overlap. **Default:** 0.0%

86 c.c.t.1 Cooling Cycle Time 1

Cycle time for cooling output in heating/cooling P.I.D. mode for process 1.
1-300 seconds **(Default:**10 s)

87 *LLP1* **Lower Limit Output Percentage 1**

Selects min. value for command output 1 percentage.
0%...100%, **Default:** 0%.

88 *uLP1* **Upper Limit Output Percentage 1**

Selects max. value for command output 1 percentage.
0%...100%, **Default:** 100%.

89 *ΠΔΕ1* **Max Gap Tune 1**

Selects the max. process-setpoint gap beyond which the automatic tune recalculates PID parameters of process 1.
0-10000 [digit^{1/p.71}] (degrees.tenths for temp. sensors). **Default:** 2.0

90 *Πn.P1* **Minimum Proportional Band 1**

Selects the min. proportional band 1 value selectable by the automatic tune for the P.I.D. regulation of process 1.
0-10000 [digit^{1/p.71}] (degrees.tenths for temp. sensors). **Default:** 3.0

91 *ΠP.P1* **Maximum Proportional Band 1**

Selects the max. proportional band 1 value selectable by the automatic tune for the P.I.D. regulation of process 1.
0-10000 [digit^{1/p.71}] (degrees.tenths for temp. sensors). **Default:** 80.0

92 *Πn.i1* **Minimum Integral Time 1**

Selects the min. integral time 1 value selectable by the automatic tune for the P.I.D. regulation of process 1.
0.0...1000.0 seconds. **Default:** 30.0 s.

93 *o.c.L1* **Overshoot Control Level 1**

The overshoot control function prevents this event during device switching on or when the setpoint is modified.

Setting a too low value the overshoot may not be fully absorbed, while with high values the process could reach the setpoint more slowly.

Disab.	Lev. 3	Lev. 6	Lev. 9
Lev. 1	Lev. 4	Lev. 7	Lev. 10
Lev. 2	Lev. 5 (Default)	Lev. 8	

94÷97 **Reserved Parameters - Group E**

Reserved parameters - Group E

GROUP F - rEE2 - Autotuning and PID 2 *(only on UR48483A/4A)***98** *tun2* **Tune 2**

Selects autotuning type for command 2
d:SRb. Disabled. If proportional band and integral time paramters are to selected to zero, the regulation is ON/OFF type. (**Default**)

Autob Automatic (Automatic P.I.D. parameters calculation)

MANu. Manual (launch by keyboards or by digital input)

oNcE Once (P.I.D. parameters calculation only at first start)

SYNcH. Synchronized (Autotuning managed by serial)

99 *S.d.t2* **Setpoint Deviation Tune 2**

Selects deviation from command setpoint 2 as threshold used by autotuning to calculate P.I.D. parameters.
0-10000 [digit^{1/p.71}] (degrees.tenths for temp. sensors). **Default:** 30.0.

100 *P.b.2* **Proportional Band 2**

Proportional band or process 2 P.I.D. regulation (Process inertia).
0 ON / OFF if t.i. equal to 0 (**Default**)
1...10000 [digit^{1/p.71}] (degrees.tenths for temp. sensors).

101 *i.t.2* **Integral Time 2**

Integral time for process 2 P.I.D. regulation (process inertia duration).
0.0...2000.0 seconds (0.0 = integral disabled), **Default** 0.0

102 *d.t.2* **Derivative Time 2**

Derivative time for process 2 P.I.D. regulation (Normally ¼ of integral time).
0.0...1000.0 seconds (0.0 = derivative disabled), **Default** 0

103 *d.b.2* **Dead Band 2**

Dead band of process 2 P.I.D.
0...10000 [digit^{1/p.71}] (degrees.tenths for temp. sensors) (**Default:** 0)

104 *P.b.c2* **Proportional Band Centered 2**

Defines if the proportional band 2 must be centered or not on the setpoint. In double loop functioning (heating/cooling), always disabled.

d:SRb. Disabled. Band under (heating) or over (cooling) (**Default**)

ENRb. Centered band

105 *o.o.S2* **Off Over Setpoint 2**

In P.I.D. enables the command output 2 switching off, when a certain threshold is exceeded (setpoint + Par.106)

d:SRb. Disabled (**Default**)

ENRb. Enabled

106 *o.d.t2* **Off Deviation Threshold 2**

Selects deviation from command setpoint 2, to calculate the intervention threshold of "Off Over Setpoint 2" function.

-9999...+9999 [digit^{1/p.71}] (degrees.tenths for temp. sensors) (**Default:** 0)

107 *c.t.2* **Cycle Time 2**

Cycle time for P.I.D. regulation of process 2 (for P.I.D. on remote control switch 15 s; for PID on SSR 2s). For valve refer to parameter 66 *uR.t2*
1-300 seconds (**Default:**15 s)

108 *co.F2* **Cooling Fluid 2**

Type of refrigerant fluid for heating / cooling P.I.D. for process 2. Enable the cooling output on parameter AL.1... AL.6.

RiP Air (**Default**)

oIL Oil

WRtEP Water

109 *P.b.Π2* **Proportional Band Multiplier 2**

Proportional band multiplier for heating/cooling P.I.D. for process 2. Proportional band for cooling action is given by parameter *P.b.2* multiplied for this value.
1.00..5.00. **Default:** 1.00

110 *o.d.b.2* **Overlap / Dead Band 2**

Dead band combination for heating / cooling P.I.D. (double action) for process 2.
-20.0..50.0%
Negative: Dead band.
Positive: overlap. **Default:** 0.0%

111 *c.c.t.2* **Cooling Cycle Time 2**

Cycle time for cooling output in heating/cooling P.I.D. mode for process 2.
1-300 seconds (**Default:** 10 s)

112 *LLP2* **Lower Limit Output Percentage 2**

Selects min. value for command output 2 percentage.
0%...100%, **Default:** 0%.

113 *uL.P2* **Upper Limit Output Percentage 2**

Selects max. value for command output 2 percentage.
0%...100%, Default: 100%.

114 *Π.G.t.2* **Max Gap Tune 2**

Selects the max. process-setpoint gap beyond which the automatic tune recalculates PID parameters of process 2.
0-10000 [digit^{1 p.71}] (degrees.tenths for temp. sensors). **Default:** 2.0

115 *Π.n.P.2* **Minimum Proportional Band 2**

Selects the min. proportional band value selectable by the automatic tune for the P.I.D. regulation of process 2.
0-10000 [digit^{1 p.71}] (degrees.tenths for temp. sensors). **Default:** 3.0

116 *Π.n.P.2* **Maximum Proportional Band 2**

Selects the max. proportional band 2 value selectable by the automatic tune for the P.I.D. regulation of process 2.
0-10000 [digit^{1 p.71}] (degrees.tenths for temp. sensors). **Default:** 80.0

117 *Π.n.i.2* **Minimum Integral Time 2**

Selects the min. integral time 2 value selectable by the automatic tune for the P.I.D. regulation of process 2.
0.0...1000.0 seconds. **Default:** 30.0 seconds.

118 *o.c.L.2* **Overshoot Control Level 2**

The overshoot control function prevents this event during device switching on or when the setpoint is modified.

Setting a too low value the overshoot may not be fully absorbed, while with high values the process could reach the setpoint more slowly.

Disab.	Lev. 6
Lev. 1	Lev. 7
Lev. 2	Lev. 8
Lev. 3	Lev. 9
Lev. 4	Lev. 10
Lev. 5 (Default)	

119÷122 **Reserved Parameters - Group F**

Reserved parameters - Group F

GROUP G - *AL. 1* - **ALARM 1**

123 *AL.1.F.* **Alarm 1 Function**

Alarm 1 selection.

d.5Rb. Disabled (**Default**)

Rb.uP.R. Absolute Upper Activation. Absolute referred to the process, active over

Rb.Lo.R. Absolute Lower Activation. Absolute referred to the process, active under

bP.Md Band alarm (command setpoint ± alarm setpoint)

uP.dEv. Upper Deviation alarm

Lo.dEv. Lower Deviation alarm

Rb.c.u.R. Absolute Command Upper Activation. Absolute alarm referred to the command setpoint, active over

Rb.c.L.R. Absolute Command Lower Activation. Absolute alarm referred to the command setpoint, active under

RUN Status alarm (active in RUN/START)

cool Cold actuator auxiliary (Cold action in double loop)

PPb.ER. Probe error. Alarm active in case of sensor rupture.

EMR.1 Related to timer 1

EMR.2 Related to timer 2

EMR.1.2 Related to both timers

REM. Remote. The alarm is enabled by the word 1235

d.i. 1 Digital Input 1. Active when digital input 1 is active.

d.i. 2 Digital Input 2. Active when digital input 2 is active.

d.i. 3 Digital Input 3. Active when digital input 3 is active.

d.i. 4 Digital Input 4. Active when digital input 4 is active.

H.b.R. Heater Break Alarm and Overcurrent Alarm

R.bP.Md Asymmetric band alarm (command setpoint + alarm setpoint 1 H and command setpoint - alarm setpoint 1 L).

*c. Ru** Auxiliary for job distribution on the command output. It cyclically replaces the command output for the time set on the parameter 134 A.1.de.. Se A.1.de. = 0, it is activated parallel to the command output. It does not work in case of valve control and can only be activated on an alarm if A.1.de. is different from 0.

124 *R.I.P.* **Alarm 1 Process (only on UR48483A/4A)**

Selects the size related to alarm 1.

R.i.N.1 Value read on input AI1. (**Default**)

R.i.N.2 Value read on input AI2.

MERH Arithmetic average of the value read on inputs AI1 and AI2 [(AI1+AI2)/2].

d.i.FF. Difference of the values read on inputs AI1 and AI2 (AI1-AI2).

Rb.d.F. Module of the difference of the values read on inputs AI1 and AI2(|AI1-AI2|).

SuM Sum of values read on inputs AI1 and AI2 (AI1+AI2).

125 *R.I.r.c.* **Alarm 1 Reference Command (only on UR48483A/4A)**

Selects alarm 1 reference command

cMd. 1 Alarm referred to command 1. (**Default**)

cMd. 2 Alarm referred to command 2.

126 *R.I.S.o.* **Alarm 1 State Output**

Alarm 1 output contact and intervention type.

N.o. St. (N.O. Start) Normally open, active at start (**Default**)

N.c. St. (N.C. Start) Normally closed, active at start

N.o. tH. (N.O. Threshold) Normally open, active on reaching alarm^{2 p.71}

N.c. tH. (N.C. Threshold) Normally closed, active on reaching alarm^{2 p.71}

127 *rES.* **Reserved**

Reserved parameter.

128 *R.1H.* Alarm 1 Hysteresis

Alarm 1 hysteresis
-9999..+9999 [digit^{1 p.71}] (degrees for temp. sensors). **Default** 0.5.

129 *R.1L.* Alarm 1 Lower Limit

Lower limit selectable for the alarm 1 setpoint.
-9999..+30000 [digit^{1 p.71}] (degrees for temp. sensors). **Default** 0.

130 *R.1U.* Alarm 1 Upper Limit

Upper limit selectable for the alarm 1 setpoint
-9999..+30000 [digit^{1 p.71}] (degrees for temp. sensors). **Default** 1750.

131 *R.1rE.* Alarm 1 Reset

Alarm 1 contact reset type (always automatic if AL.1.F. = c. Aux).
R. RES. Automatic reset (**Default**)
M. RES. Manual reset (manual reset by keyboard or by digital input)
M.RES.5. Stored manual reset (keeps the output status also after a power failure)
R. RES.t. Automatic reset with timed activation. The alarm remains active for the time set on the parameter 134 a.1.de., even if the conditions generating it are missing. To be able to act again, the alarm conditions must disappear.

132 *R.1SE.* Alarm 1 State Error

Alarm 1 output status in case of error.
oPEN Open contact. **Default**
cLoSE Closed contact.

133 *R.1Ld.* Alarm 1 Led

Defines the status of the led **A1** in correspondence of the relevant output
a.c. ON with open contact or DO switched off.
c.c. ON with closed contact or DO switched on. (**Default**)

134 *R.1dE.* Alarm 1 Delay

Alarm 1 Delay.
-60:00..60:00 mm:ss (hh:mm if *AL.1.F.* = c. *Ru**). **Default**: 00:00.
Negative value: delay when exit alarm status.
Positive value: delay when enter alarm status.

135 *R.1SP.* Alarm 1 Setpoint Protection

Allows or not to change the alarm 1 setpoint
FREE Editable by the user (**Default**)
Lock Protected
Hi dE Protected and not visualized

136 *R.1Lb.* Alarm 1 Label

Selects the message displayed in case of alarm 1 intervention.
d15Rb. Disabled. (**Default**) 0.
Lb. 01 Message 1 (see table on paragraph 14.1)
..
Lb. 15 Message 16 (see table on paragraph 14.1)
uSER.L. Custom message (modifiable by the user through the App or via modbus)

137÷140 Reserved Parameters - Group G

Reserved parameters - Group G

GRUPPO H - *AL. 2* - Alarm 2

141 *AL2F.* Alarm 2 Function

Alarm 2 selection.
d15Rb. Disabled (**Default**)
Rb.uP.R. Absolute Upper Activation. Absolute referred to the process, active over
Rb.Lo.R. Absolute Lower Activation. Absolute referred to the process, active under
bRNd Band alarm (command setpoint ± alarm setpoint)
uP.dEV. Upper Deviation alarm
Lo.dEV. Lower Deviation alarm
Rb.c.u.R. Absolute Command Upper Activation. Absolute alarm referred to the command setpoint, active over
Rb.c.l.R. Absolute Command Lower Activation. Absolute alarm referred to the command setpoint, active under
RuN Status alarm (active in RUN/START)
cool Cold actuator auxiliary (Cold action in double loop)
PPb.ER. Probe error. Alarm active in case of sensor ropture.
tMR.1 Related to timer 1
tMR.2 Related to timer 2
tMR.1.2 Related to both timers
REM. Remote. The alarm is enabled by the word 1236
d.i. 1 Digital Input 1. Active when digital input 1 is active.
d.i. 2 Digital Input 2. Active when digital input 2 is active.
d.i. 3 Digital Input 3. Active when digital input 3 is active.
d.i. 4 Digital Input 4. Active when digital input 4 is active.
H.b.R. Heater Break Alarm and Overcurrent Alarm
R.bRNd Asymmetric band alarm (command setpoint + alarm setpoint 2 H and command setpoint - alarm setpoint 2 L).
*c. Ru** Auxiliary for job distribution on the command output. It cyclically replaces the command output for the time set on the parameter 152 *R.2.dE.*. If *R.2.dE.* = 0, it is activated parallel to the command output. It does not work in case of valve control and can only be activated on an alarm if *R.2.dE.* is different from 0.

142 *R2PF.* Alarm 2 Process (only on UR48483A/4A)

Selects the size related to alarm 2.
R.in.1 Value read on input AI1. (**Default**)
R.in.2 Value read on input AI2.
MERH Arithmetic average of the value read on inputs AI1 and AI2 [(AI1+AI2)/2].
d1FF. Difference of the values read on inputs AI1 and AI2 (AI1-AI2).
Rb.d1F. Module of the difference of the values read on inputs AI1 and AI2(|AI1-AI2|).
Sum Sum of values read on inputs AI1 and AI (AI1+AI2).

143 *R2rc.* Alarm 2 Reference Command (only on UR48483A/4A)

Selects alarm 2 reference command
cMd. 1 Alarm referred to command 1. (**Default**)
cMd. 2 Alarm referred to command 2.

144 *R2So.* Alarm 2 State Output

Alarm 2 output contact and intervention type.
N.o. 5t. (N.O. Start) Normally open, active at start (**Default**)
N.c. 5t. (N.C. Start) Normally closed, active at start
N.o. tH. (N.O. Threshold) Normally open, active on reaching alarm^{2 p.71}
N.c. tH. (N.C. Threshold) Normally closed, active on reaching alarm^{2 p.71}

145 *rES.* Reserved

Reserved parameter.

146 *R2H.* Alarm 2 Hysteresis

Alarm 2 hysteresis
-9999..+9999 [digit^{1 p.71}] (degrees for temp. sensors). **Default** 0.5.

147 *R2LL.* Alarm 2 Lower Limit

Lower limit selectable for the alarm 2 setpoint.
-9999..+30000 [digit^{1 p.71}] (degrees for temp. sensors). **Default** 0.

148 *R2UL.* Alarm 2 Upper Limit

Upper limit selectable for the alarm 2 setpoint
-9999..+30000 [digit^{1 p.71}] (degrees for temp. sensors). **Default** 1750.

149 *R2rE.* Alarm 2 Reset

Alarm 2 contact reset type (always automatic if *RL.z.F. = c. Ru**).
R. RES. Automatic reset (**Default**)
M. RES. Manual reset (manual reset by keyboard or by digital input)
M.RES.5. Stored manual reset (keeps the output status also after a power failure)
R. RES.L. Automatic reset with timed activation. The alarm remains active for the time set on the parameter 152 *R.z.dE.*, even if the conditions generating it are missing. To be able to act again, the alarm conditions must disappear.

150 *R2SE.* Alarm 2 State Error

Alarm 2 output status in case of error

If the alarm output is relay

aPEN Contact or open valve. **Default** *cLo5E* Contact or closed valve.

If the alarm output is digital (SSR):

aFF Digital output OFF. **Default** *aH* Digital output ON.

151 *R2Ld.* Alarm 2 Led

Defines the status of the led **A2** in correspondence of the relevant output.

a.c. ON with open contact or DO switched off.

c.c. ON with closed contact or DO switched on. (**Default**)

152 *R2.dE.* Alarm 2 Delay

Alarm 2 Delay.

-60:00..60:00 mm:ss (hh:mm if *RL.z.F. = c. Ru**). **Default**: 00:00.

Negative value: delay when exit alarm status.

Positive value: delay when enter alarm status

153 *R2S.P.* Alarm 2 Setpoint Protection

Allows or not to change the alarm 2 setpoint

FREE Editable by the user (**Default**)

LoCK Protected

HidE Protected and not visualized

154 *R2Lb.* Alarm 2 Label

Selects the message displayed in case of alarm 2 intervention.

d.5Rb. Disabled. (**Default**) 0.

Lb. 01 Message 1 (see table on paragraph 14.1)

..

Lb. 20 Message 20 (see table on paragraph 14.1)

uSER.L. Custom message (modifiable by the user through the App or via modbus)

155÷158 Reserved Parameters - Group H

Reserved parameters - Group H

GROUP I - *RL. 3* - Alarm 3

159 *RL3.F.* Alarm 3 Function

Alarm 3 selection.

d.5Rb. Disabled (**Default**)

Rb.uP.R. Absolute Upper Activation. Absolute referred to the process, active over

Rb.Lo.R. Absolute Lower Activation. Absolute referred to the process, active under

bRNd Band alarm (command setpoint ± alarm setpoint)

uP.dEV. Upper Deviation alarm

Lo.dEV. Lower Deviation alarm

Rb.c.u.R. Absolute Command Upper Activation. Absolute alarm referred to the command setpoint, active over

Rb.c.L.R. Absolute Command Lower Activation. Absolute alarm referred to the command setpoint, active under

RuN Status alarm (active in RUN/START)

cooL Cold actuator auxiliary (Cold action in double loop)

PPb.ER. Probe error. Alarm active in case of sensor rupture.

tMR.1 Related to timer 1

tMR.2 Related to timer 2

tMR.1.2 Related to both timers

REM. Remote. The alarm is enabled by the word 1237

d.i. 1 Digital Input 1. Active when digital input 1 is active.

d.i. 2 Digital Input 2. Active when digital input 2 is active.

d.i. 3 Digital Input 3. Active when digital input 3 is active.

d.i. 4 Digital Input 4. Active when digital input 4 is active.

H.b.R. Heater Break Alarm e Overcurrent Alarm

R.bRNd Asymmetric band alarm (command setpoint + alarm setpoint 3 H and command setpoint - alarm setpoint 3 L).

*c. Ru** Auxiliary for job distribution on the command output. It cyclically replaces the command output for the time set on the parameter 170 *R.3.dE.* If *R.3.dE. = 0*, it is activated parallel to the command output. It does not work in case of valve control and can only be activated on an alarm if *R.3.dE.* is different from 0.

160 *R3P.* Alarm 3 Process (only on UR48483A/4A)

Selects the size related to alarm 3.

R.iN.1 Value read on input AI1. (**Default**)

R.iN.2 Value read on input AI2.

MERH Arithmetic average of the value read on inputs AI1 and AI2 [(AI1+AI2)/2].

d.iFF. Difference of the values read on inputs AI1 and AI2 (AI1-AI2).

Rb.d.F. Module of the difference of the values read on inputs AI1 and AI2 (|AI1-AI2|).

Sum Sum of values read on inputs AI1 and AI2 (AI1+AI2).

161 *R3r.c.* Alarm 3 Reference Command (only on UR48483A/4A)

Selects alarm 3 reference command

cMd. 1 Alarm referred to command 1. (**Default**)

cMd. 2 Alarm referred to command 2.

162 *R3S.o.* Alarm 3 State Output

Alarm 3 output contact and intervention type..

N.o. 5E. (N.O. Start) Normally open, active at start (**Default**)

N.c. 5E. (N.C. Start) Normally closed, active at start

N.o. tH. (N.O. Threshold) Normally open, active on reaching alarm^{2 p.71}

N.c. tH. (N.C. Threshold) Normally closed, active on reaching alarm^{2 p.71}

163 *AL3o.t.* **Alarm 3 Output Type**

Defines the output type if the alarm 3 is analogue.

0.V Output 0...10 V. **Default**

4.20mA Output 4...20 mA.

164 *AL3HY.* **Alarm 3 Hysteresis**

Alarm 3 hysteresis.

-9999..+9999 [digit^{1p.71}] (degrees for temp. sensors). **Default** 0.5.

165 *AL3LL* **Alarm 3 Lower Limit**

Lower limit selectable for the alarm 3 setpoint.

-9999..+30000 [digit^{1p.71}] (degrees for temp. sensors). **Default** 0.

166 *AL3UL.* **Alarm 3 Upper Limit**

Upper limit selectable for the alarm 3 setpoint

-9999..+30000 [digit^{1p.71}] (degrees for temp. sensors). **Default** 1750.

167 *AL3rE.* **Alarm 3 Reset**

Alarm 3 contact reset type (always automatic if *AL3.F.* = *c. Ru**).

R. RES. Automatic reset (**Default**)

M. RES. Manual reset (manual reset by keyboard or by digital input)

M.RES.5. Stored manual reset (keeps the output status also after a power failure)

R. RES.E. Automatic reset with timed activation. The alarm remains active for the time set on the parameter 170 *R.3.dE.*, even if the conditions generating it are missing. To be able to act again, the alarm conditions must disappear.

168 *AL3SE.* **Alarm 3 State Error**

Alarm 3 output status in case of error.

If the alarm output is relay

aPEN Contact or open valve. **Default**

cLoSE Contact or closed valve.

If the alarm output is digital (SSR):

aFF Digital output OFF. **Default**

aN Digital output ON.

If the alarm output is 0-10V:

0 V 0 V. **Default**

10 V 10 V.

If the alarm output is 0-20 mA or 4-20 mA:

0 mA 0 mA. **Default**

20 mA 20 mA.

4 mA 4 mA.

21.5mA 21.5 mA.

169 *AL3Ld.* **Alarm 3 Led**

Defines the status of the led **A3** in correspondence of the relevant output.

a.c. ON with open contact, DO switched off or AO deactivated.

c.c. ON with closed contact, DO switched on or AO activated. (**Default**)

170 *AL3dE.* **Alarm 3 Delay**

Alarm 3 Delay.

-60:00..60:00 mm:ss (hh:mm if *AL3.F.* = *c. Ru**). **Default**: 00:00.

Negative value: delay when exit alarm status.

Positive value: delay when enter alarm status

171 *AL3SP.* **Alarm 3 Setpoint Protection**

Allows or not to change the alarm 3 setpoint.

FREE Editable by the user (**Default**)

LoCK Protected

HiDE Protected and not visualized

172 *AL3Lb.* **Alarm 3 Label**

Selects the message displayed in case of alarm 3 intervention.

d.5Rb. Disabled. (**Default**) 0.

Lb. 01 Message 1 (see table on paragraph 14.1)

..

Lb. 20 Message 20 (see table on paragraph 14.1)

uSER.L. Custom message (modifiable by the user through the App or via modbus)

173÷176 **Reserved Parameters - Group I**

Reserved parameters - Group I

GROUP J - AL 4 - Alarm 4**177** *AL4.F.* **Alarm 4 Function**

Alarm 4 selection.

d.5Rb. Disabled (**Default**)

Rb.uP.R. Absolute Upper Activation. Absolute referred to the process, active over

Rb.Lo.R. Absolute Lower Activation. Absolute referred to the process, active under

bAND Band alarm (command setpoint ± alarm setpoint)

uP.dEV. Upper Deviation alarm

Lo.dEV. Lower Deviation alarm

Rb.c.u.R. Absolute Command Upper Activation. Absolute alarm referred to the command setpoint, active over

Rb.c.L.R. Absolute Command Lower Activation. Absolute alarm referred to the command setpoint, active under.

RuN Status alarm (active in RUN/START)

cCoL Cold actuator auxiliary (Cold action in double loop)

PRb.ER. Probe error. Alarm active in case of sensor rupture.

tMR.1 Related to timer 1

tMR.2 Related to timer 2

tMR.1.2 Related to both timers

REM. Remote. The alarm is enabled by the word 1238

d.i. 1 Digital Input 1. Active when digital input 1 is active.

d.i. 2 Digital Input 2. Active when digital input 2 is active.

d.i. 3 Digital Input 3. Active when digital input 3 is active.

d.i. 4 Digital Input 4. Active when digital input 4 is active.

H.b.R. Heater Break Alarm and Overcurrent Alarm

R.bAND Asymmetric band alarm (command setpoint + alarm setpoint 4 H and command setpoint - alarm setpoint 4 L).

*c. Ru** Auxiliary for job distribution on the command output. It cyclically replaces the command output for the time set on the parameter 188 *R.4.dE.* If *R.4.dE.* = 0, it is activated parallel to the command output. It does not work in case of valve control and can only be activated on an alarm if *R.4.dE.* is different from 0.

178 *AL4P.* **Alarm 4 Process (only on UR48483A/4A)**

Selects the size related to alarm 4.

R.i.N.1 Value read on input AI1. (**Default**)

R.i.N.2 Value read on input AI2.

MERN Arithmetic average of the value read on inputs AI1 and AI2 [(AI1+AI2)/2].

d.i.FF. Difference of the values read on inputs AI1 and AI2 (AI1-AI2).

Rb.d.F. Module of the difference of the values read on inputs AI1 and AI2 (|AI1-AI2|).

Sum Sum of values read on inputs AI1 and AI2 (AI1+AI2).

179 *AL.C.* **Alarm 4 Reference Command**

Selects alarm 4 reference command
cmd. 1 Alarm referred to command 1. **(Default)**
cmd. 2 Alarm referred to command 2.

180 *AL.S.O.* **Alarm 4 State Output**

Alarm 4 output contact and intervention type.
N.O. St. (N.O. Start) Normally open, active at start **(Default)**
N.C. St. (N.C. Start) Normally closed, active at start
N.O. Th. (N.O. Threshold) Normally open, active on reaching alarm^{2 p.71}
N.C. Th. (N.C. Threshold) Normally closed, active on reaching alarm^{2 p.71}

181 *AL.O.T.* **Alarm 4 Output Type**

Defines the output type if the alarm 4 is analogue.
0..10 V Output 0...10 V. **Default**
4..20 mA Output 4...20 mA.

182 *AL.H.* **Alarm 4 Hysteresis**

Alarm 4 hysteresis.
 -9999..+9999 [digit^{1 p.71}] (degrees for temp. sensors). **Default 0.5.**

183 *AL.L.* **Alarm 4 Lower Limit**

Lower limit selectable for the alarm 4 setpoint.
 -9999..+30000 [digit^{1 p.71}] (gradi per sensori di temperatura). **Default 0.**

184 *AL.U.L.* **Alarm 4 Upper Limit**

Upper limit selectable for the alarm 4 setpoint.
 -9999..+30000 [digit^{1 p.71}] (degrees for temp. sensors). **Default 1750.**

185 *AL.R.* **Alarm 4 Reset**

Alarm 4 contact reset type (always automatic if *AL.C.F. = c. Ru**).
R. RES. Automatic reset **(Default)**
M. RES. Manual reset (manual reset by keyboard or by digital input)
M.RES.5. Stored manual reset (keeps the output status also after a power failure)
R. RES.t. Automatic reset with timed activation. The alarm remains active for the time set on the parameter 188 *R.C.dE.*, even if the conditions generating it are missing. To be able to act again, the alarm conditions must disappear.

186 *AL.S.E.* **Alarm 4 State Error**

Alarm 4 output status in case of error.
If the alarm output is digital (SSR):
OFF Digital output OFF. **Default** *ON* Digital output ON.
If the alarm output is 0-10V:
0 V 0 V. **Default** *10 V* 10 V.
If the alarm output is 0-20 mA or 4-20 mA:
0 mA 0 mA. **Default** *20 mA* 20 mA.
4 mA 4 mA. *21.5 mA* 21.5 mA.

187 *rES.* **Reserved**

Reserved parameter

188 *AL.dE.* **Alarm 4 Delay**

Alarm 4 Delay.
 -60:00..60:00 mm:ss (hh:mm if *AL.C.F. = c. Ru**). **Default: 00:00.**
 Negative value: delay when exit alarm status.
 Positive value: delay when enter alarm status

189 *AL.S.P.* **Alarm 4 Setpoint Protection**

Allows or not to change the alarm 4 setpoint.
FREE Editable by the user **(Default)**
LOCK Protected
Hide Protected and not visualized

190 *AL.Lb.* **Alarm 4 Label**

Selects the message displayed in case of alarm 4 intervention.
disAb. Disabled. **(Default) 0.**
Lb. 01 Message 1 (see table on paragraph 14.1)
 ..
Lb. 20 Message 20 (see table on paragraph 14.1)
USER.L. Custom message (modifiable by the user through the App or via modbus)

191÷194 **Reserved Parameters - Group J**

Reserved parameters - Group J

GROUP K - AL. 5 - Alarm 5 *(only on UR48483A/4A/5A)***195** *AL.S.F.* **Alarm 5 Function**

Alarm 5 selection 5.
disAb. Disabled **(Default)**
Rb. uP.R. Absolute Upper Activation. Absolute referred to the process, active over
Rb. Lo.R. Absolute Lower Activation. Absolute referred to the process, active under
band Band alarm (command setpoint ± alarm setpoint)
uP.dEV. Upper Deviation. alarm
Lo.dEV. Lower Deviation alarm
Rb.c.u.R. Absolute Command Upper Activation. Absolute alarm referred to the command setpoint, active over.
Rb.c.l.R. Absolute Command Lower Activation. Absolute alarm referred to the command setpoint, active under
RuN Status alarm (active in RUN/START)
cool Cold actuator auxiliary (Cold action in double loop)
PRb.ER. Probe error. Alarm active in case of sensor rupture.
EMR.1 Related to timer 1
EMR.2 Related to timer 2
EMR.1.2 Related to both timers
REM. Remote. The alarm is enabled by the word 1239
d.i. 1 Digital Input 1. Active when digital input 1 is active.
d.i. 2 Digital Input 2. Active when digital input 2 is active.
d.i. 3 Digital Input 3. Active when digital input 3 is active.
d.i. 4 Digital Input 4. Active when digital input 4 is active.
H.b.R. Heater Break Alarm and Overcurrent Alarm
R.band Asymmetric band alarm (command setpoint + alarm setpoint 5 H and command setpoint - alarm setpoint 5 L).
*c. Ru** Auxiliary for job distribution on the command output. It cyclically replaces the command output for the time set on the parameter 206 *R.5.dE.* If *R.5.dE. = 0*, it is activated parallel to the command output. It does not work in case of valve control and can only be activated on an alarm if *R.5.dE.* is different from 0.

- 196** *RS.P.* **Alarm 5 Process** (only on UR48483A/4A)
 Selects the size related to alarm 5.
R.N.1 Value read on input AI1. **(Default)**
R.N.2 Value read on input AI2.
MERH Arithmetic average of the value read on inputs AI1 and AI2 $[(AI1+AI2)/2]$.
dIFF Difference of the values read on inputs AI1 and AI2 $AI1-AI2$.
Ab.d.F. Module of the difference of the values read on inputs AI1 and AI2 $|AI1-AI2|$.
Sum Sum of values read on inputs AI1 and AI2 $(AI1+AI2)$.
- 197** *RS.r.c.* **Alarm 5 Reference Command** (only on UR48483A/4A)
 Selects alarm 5 reference command
cmd. 1 Alarm referred to command 1. **(Default)**
cmd. 2 Alarm referred to command 2.
- 198** *RS.o.* **Alarm 5 State Output**
 Contatto uscita allarme 5 e tipo intervento.
N.o. St. (N.O. Start) Normally open, active at start **(Default)**
N.c. St. (N.C. Start) Normally closed, active at start
N.o. TH. (N.O. Threshold) Normally open, active on reaching alarm^{2 p.71}
N.c. TH. (N.C. Threshold) Normally closed, active on reaching alarm^{2 p.71}
- 199** *RS.o.t.* **Alarm 5 Output Type**
 Defines the output type if the alarm 5 is analogue.
0.10 V Output 0...10 V. **Default**
4.20mA Output 4...20 mA.
- 200** *RS.H.* **Alarm 5 Hysteresis**
 Alarm 5 hysteresis.
 -9999..+9999 [digit^{1 p.71}] (degrees for temp. sensors). **Default** 0.5.
- 201** *RS.LL.* **Alarm 5 Lower Limit**
 Lower limit selectable for the alarm 5 setpoint.
 -9999..+30000 [digit^{1 p.71}] (degrees for temp. sensors). **Default** 0.
- 202** *RS.U.L.* **Alarm 5 Upper Limit**
 Upper limit selectable for the alarm 5 setpoint.
 -9999..+30000 [digit^{1 p.71}] (degrees for temp. sensors). **Default** 1750.
- 203** *RS.r.E.* **Alarm 5 Reset**
 Alarm 5 contact reset type (always automatic if *RL.S.F.* = *c. Ru**).
R. RES. Automatic reset **(Default)**
M. RES. Manual reset (manual reset by keyboard or by digital input)
M.RES.S. Stored manual reset (keeps the output status also after a power failure)
R. RES.t. Automatic reset with timed activation. The alarm remains active for the time set on the parameter 206 *R.S.dE.*, even if the conditions generating it are missing. To be able to act again, the alarm conditions must disappear.

- 204** *RSSE.* **Alarm 5 State Error**
 Alarm 5 output status in case of error.
If the alarm output is digital (SSR):
oFF Digital output OFF. **Default** *oN* Digital output ON.
If the alarm output is 0-10V:
0 V 0 V. **Default** *10 V* 10 V.
If the alarm output is 0-20 mA or 4-20 mA:
0 mA 0 mA. **Default** *20 mA* 20 mA.
4 mA 4 mA. *21.5mA* 21.5 mA.
- 205** *rES.* **Reserved**
 Reserved parameter
- 206** *RS.dE.* **Alarm 5 Delay**
 Alarm 5 delay.
 -60:00..60:00 mm:ss (hh:mm if *RL.S.F.* = *c. Ru**). **Default:** 00:00.
 Negative value: delay when exit alarm status.
 Positive value: delay when enter alarm status
- 207** *RS.S.P.* **Alarm 5 Setpoint Protection**
 Allows or not to change the alarm 5 setpoint.
FREE Editable by the user **(Default)**
Lock Protected
Hide Protected and not visualized
- 208** *RS.Lb.* **Alarm 5 Label**
 Selects the message displayed in case of alarm 5 intervention.
disAb. Disabled. **(Default)** 0.
Lb. 01 Message 1 (see table on paragraph 14.1)
 ..
Lb. 20 Message 20 (see table on paragraph 14.1)
uSEP.L. Custom message (modifiable by the user through the App or via modbus)
- 209÷212** **Reserved Parameters - Group K**
 Reserved parameters - Group K

GROUP L - RL 5 - Alarm 6 (only on UR48483A/4A)

213 RL5.F. Alarm 6 Function

Alarm 6 selection.

- d15Rb. Disabled (**Default**)
- Rb.uP.R. Absolute Upper Activation. Absolute referred to the process, active over
- Rb.Lo.R. Absolute Lower Activation. Absolute referred to the process, active under
- bRNd Band alarm (command setpoint ± alarm setpoint)
- uP.dE.V. Upper Deviation alarm
- Lo.dE.V. Lower Deviation alarm
- Rb.c.u.R. Absolute Command Upper Activation. Absolute alarm referred to the command setpoint, active over.
- Rb.c.L.R. Absolute Command Lower Activation. Absolute alarm referred to the command setpoint, active under.
- RuN Status alarm (active in RUN/START)
- cooL Cold actuator auxiliary (Cold action in double loop)
- PPb.ER. Probe error. Alarm active in case of sensor ropture.
- tMR.1 Related to timer 1
- tMR.2 Related to timer 2
- tMR.1.2 Related to both timers
- REM. Remote. The alarm is enabled by the word 1240
- d.i. 1 Digital Input 1. Active when digital input 1 is active.
- d.i. 2 Digital Input 2. Active when digital input 2 is active.
- d.i. 3 Digital Input 3. Active when digital input 3 is active.
- d.i. 4 Digital Input 4. Active when digital input 4 is active.
- H.b.R. Heater Break Alarm and Overcurrent Alarm
- R.bRNd Asymmetric band alarm (command setpoint + alarm setpoint 6 H and command setpoint - alarm setpoint 6 L).
- c. Ru* Auxiliary for job distribution on the command output. It cyclically replaces the command output for the time set on the parameter 224 R.5.dE.. If R.5.dE. = 0, it is activated parallel to the command output. It does not work in case of valve control and can only be activated on an alarm if R.5.dE. is different from 0.

214 RBPr. Alarm 6 Process

Selects the size related to alarm 6.

- R.i.N.1 Value read on input AI1. (**Default**)
- R.i.N.2 Value read on input AI2.
- MERH Arithmetic average of the value read on inputs AI1 and AI2 $[(AI1+AI2)/2]$.
- d1FF. Difference of the values read on inputs AI1 and AI2 $(AI1-AI2)$.
- Rb.d1F. Module of the difference of the values read on inputs AI1 and AI2 $(|AI1-AI2|)$.
- SuM Sum of values read on inputs AI1 and AI2 $(AI1+AI2)$.

215 RBrc. Alarm 6 Reference Command

Selects alarm 6 reference command

- cMd. 1 Alarm referred to command 1. (**Default**)
- cMd. 2 Alarm referred to command 2.

216 RBSo. Alarm 6 State Output

Alarm 6 output contact and intervention type.

- N.o. 5E. (N.O. Start) Normally open, active at start (**Default**)
- N.c. 5E. (N.C. Start) Normally closed, active at start
- N.o. tH. (N.O. Threshold) Normally open, active on reaching alarm^{2p.71}
- N.c. tH. (N.C. Threshold) Normally closed, active on reaching alarm^{2p.71}

217 RB.o.t. Alarm 6 Output Type

Defines the output type if the alarm 6 is analogue.

- 0.10 V Output 0...10 V. **Default**
- 4.20mA Output 4...20 mA.

218 RBHy. Alarm 6 Hysteresis

Alarm 6 hysteresis

-9999..+9999 [digit^{1p.71}] (degrees.tenths for temp. sensors). **Default** 0.5.

219 RBLL. Alarm 6 Lower Limit

Lower limit selectable for the alarm 6 setpoint.

-9999..+30000 [digit^{1p.71}] (degrees for temp. sensors). **Default** 0.

220 RBuL. Alarm 6 Upper Limit

Upper limit selectable for the alarm 6 setpoint.

-9999..+30000 [digit^{1p.71}] (degrees for temp. sensors). **Default** 1750.

221 RB.rE. Alarm 6 Reset

Alarm 6 contact reset type (always automatic if RL.5.F. = c. Ru*).

- R. RES. Automatic reset (**Default**)
- M. RES. Manual reset (manual reset by keyboard or by digital input)
- M.RES.5. Stored manual reset (keeps the output status also after a power failure)
- R. RES.t. Automatic reset with timed activation. The alarm remains active for the time set on the parameter 224 R.5.dE., even if the conditions generating it are missing. To be able to act again, the alarm conditions must disappear.

222 RBSE. Alarm 6 State Error

Alarm 6 output status in case of error.

If the alarm output is 0-10V:

0 V 0 V. **Default** 10 V 10 V.

If the alarm output is 0-20 mA or 4-20 mA:

0 mA 0 mA. **Default** 20 mA 20 mA.
4 mA 4 mA. 21.5mA 21.5 mA.

223 rES. Reserved

Reserved parameter

224 RB.dE. Alarm 6 Delay

Alarm 6 Delay.

-60:00..60:00 mm:ss (hh:mm if RL.5.F. = c. Ru*). **Default**: 00:00.

Negative value: delay when exit alarm status

Positive value: delay when enter alarm status

225 RBSP. Alarm 6 Setpoint Protection

Allows or not to change the alarm 6 setpoint.

- FPEE Editable by the user (**Default**)
- LoCK Protected
- Hi.dE Protected and not visualized

226 RB.Lb. Alarm 6 Label

Selects the message displayed in case of alarm 6 intervention.

- d15Rb. Disabled. (**Default**) 0.
- Lb. 01 Message 1 (see table on paragraph 14.1)
- ..
- Lb. 20 Message 20 (see table on paragraph 14.1)
- uSEP.L. Custom message (modifiable by the user through the App or via modbus)

227÷230 Reserved Parameters - Group L

Reserved parameters - Group L

GROUP M - d. i. 1 - Digital input 1**231 d. i. 1.F. Digital Input 1 Function**

Digital input 1 functioning.

d.i.SRb.	Disabled (Default)
2E. SM.	2 Setpoints Switch
2E.SM.i.	2 Setpoints Switch Impulsive
3E.SM.i.	3 Setpoints Switch Impulsive
4E.SM.i.	4 Setpoints Switch Impulsive
5E./5E.	Start / Stop
RuN	Run
HoLd	Lock conversion (stop all conversions and display values)
EuNE	Performing manual tune
Ru.MR.i.	Automatic / Manual Impulse (if enabled on parameter 48 or 67)
Ru.MR.c.	Automatic / Manual Contact (if enabled on parameter 48 or 67)
RcE.tY.	Action Type. Cooling regulat. if D.I. is active, otherwise heating reg.
R.i. 0	Analogue Input 0. Set AI to zero
M. RES.	Manual reset. Reset the outputs if selected as manual reset.
E.1.RuN	Timer 1 run. The timer 1 count with activated D.I.
E.1.S.E.	Timer 1 Start End. D.I. starts and stops the timer 1(impulsive)
E.1.SEtR.	Timer 1 Start. D.I. starts the timer 1(impulsive)
E.1.EMd	Timer 1 End. D.I. stops the timer 1(impulsive)
E.2.RuN	Timer 2 run. The timer 2 count with activated D.I.
E.2.S.E.	Timer 2 Start End. D.I. starts and stops the timer 2(impulsive)
E.2.SEtR.	Timer 2 Start. D.I. starts the timer 2(impulsive)
E.2.EMd	Timer 2 End. D.I. stops the timer 2(impulsive)
Lo.cFG.	Lock configuration and setpoints.
uP.kEY	Simulates the functioning of up key.
dOwN.k.	Simulates the functioning of down key.
Fnc. k.	Simulates the functioning of fnd key.
SEt. k.	Simulates the functioning of set key.
REM.S.E.	Remote setpoint enabling. Enables Remote setpoint with activated D.I. Local setpoint with deactivated D.I. (remote setpoint must be enabled on parameter 56 rEfl.5.)
E%t.RL.	External alarm. The controller goes on STOP and the alarms will be disabled. The controller does not return to START automatically; for this operation, the user's intervention is required.

232 d. i. 1.c. Digital Input 1 Contact

Defines the resting contact of the digital input 1.

N.oPEN	Normally open (Default)
N.cLoS.	Normally closed

233 d. i. 1.P. Digital Input 1 Process (only on UR48483A/4A)

Select the size related to the digital input 1.

R.i.N.1	Value read on input AI1. (Default)
R.i.N.2	Value read on input AI2.
MERu	Arithmetic average of the value read on inputs AI1 and AI2 $[(AI1-AI2)/2]$.
d.i.FF.	Difference of the values read on inputs AI1 and AI2 $(AI1-AI2)$.
Rb.d.i.F.	Module of the difference of the values read on inputs AI1 and AI2 $(AI1-AI2)$.
SuM	Sum of values read on inputs AI1 and AI2 $(AI1+AI2)$.

234 d. i. 1.r. Digital Input 1 Reference Command

Defines the resting contact of the digital input 1.

cMd. 1	Command 1 (Default)
cMd. 2	Command 2
cMd.1.2	Command 1 and 2

235÷238 Reserved Parameters - Group M

Reserved parameters - Group M

GROUP N - d. i. 2 - Digital input 2**239 d. i. 2.F. Digital Input 2 Function**

Digital input 2 functioning.

d.i.SRb.	Disabled (Default)
2E. SM.	2 Setpoints Switch
2E.SM.i.	2 Setpoints Switch Impulsive
3E.SM.i.	3 Setpoints Switch Impulsive
4E.SM.i.	4 Setpoints Switch Impulsive
5E./5E.	Start / Stop
RuN	Run
HoLd	Lock conversion (stop all conversions and display values)
EuNE	Performing manual tune
Ru.MR.i.	Automatic / Manual Impulse (if enabled on parameter 48 or 67)
Ru.MR.c.	Automatic / Manual Contact (if enabled on parameter 48 or 67)
RcE.tY.	Action Type. Cooling regulation if D.I. is active, otherwise heating reg.
R.i. 0	Analogue Input 0. Set AI to zero
M. RES.	Manual reset. Reset the outputs if selected as manual reset.
E.1.RuN	Timer 1 run. The timer 1 count with activated D.I.
E.1.S.E.	Timer 1 Start End. D.I. starts and stops the timer 1(impulsive)
E.1.SEtR.	Timer 1 Start. D.I. starts the timer 1(impulsive)
E.1.EMd	Timer 1 End. D.I. stops the timer 1(impulsive)
E.2.RuN	Timer 2 run. The timer 2 count with activated D.I.
E.2.S.E.	Timer 2 Start End. D.I. starts and stops the timer 2(impulsive)
E.2.SEtR.	Timer 2 Start. D.I. starts the timer 2(impulsive)
E.2.EMd	Timer 2 End. D.I. stops the timer 2(impulsive)
Lo.cFG.	Lock configuration and setpoints.
uP.kEY	Simulates the functioning of up key.
dOwN.k.	Simulates the functioning of down key.
Fnc. k.	Simulates the functioning of fnc key.
SEt. k.	Simulates the functioning of set key.
REM.S.E.	Remote setpoint enabling. Enables Remote setpoint with activated D.I. Local setpoint with deactivated D.I. (remote setpoint must be enabled on parameter 56 rEfl.5.)
E%t.RL.	External alarm. The controller goes on STOP and the alarms will be disabled. The controller does not return to START automatically; for this operation, the user's intervention is required.

240 d. i. 2.c. Digital Input 2 Contact

Defines the resting contact of the digital input 2.

N.oPEN	Normally open (Default)
N.cLoS.	Normally closed

241 d. i. 2.P. Digital Input 2 Process (only on UR48483A/4A)

Select the size related to the digital input 2.

R.i.N.1	Value read on input AI1. (Default)
R.i.N.2	Value read on input AI2.

<i>MERN</i>	Arithmetic average of the value read on inputs AI1 and AI2 $[(AI1-AI2)/2]$.
<i>d.FF.</i>	Difference of the values read on inputs AI1 and AI2 $(AI1-AI2)$.
<i>Rb.d.F.</i>	Module of the difference of the values read on inputs AI1 and AI2 $(AI1-AI2)$.
<i>Sum</i>	Sum of values read on inputs AI1 and AI2 $(AI1+AI2)$.

242 *d.i.2.r.* Digital Input 2 Reference Command

Defines the resting contact of the digital input 2.

<i>cMd. 1</i>	Command 1 (Default)
<i>cMd. 2</i>	Command 2
<i>cMd.1.2</i>	Command 1 and 2

243÷246 Reserved Parameters - Group N

Reserved parameters - Group N

GROUP O - *d. i. 3* - Digital input 3 (only on UR48483A/4A)

247 *d.i.3.F.* Digital Input 3 Function

Digital input 3 functioning.

<i>d.SRb.</i>	Disabled (Default)
<i>2E. SM.</i>	2 Setpoints Switch
<i>2E.SM.i.</i>	2 Setpoints Switch Impulsive
<i>3E.SM.i.</i>	3 Setpoints Switch Impulsive
<i>4E.SM.i.</i>	4 Setpoints Switch Impulsive
<i>SE./SE.</i>	Start / Stop
<i>RUN</i>	Run
<i>HoLd</i>	Lock conversion (stop all conversions and display values)
<i>tUNE</i>	Performing manual tune
<i>Ru.MR.i.</i>	Automatic / Manual Impulse (if enabled on parameter 48 or 67)
<i>Ru.MR.c.</i>	Automatic / Manual Contact (if enabled on parameter 48 or 67)
<i>RcE.tY.</i>	Action Type. Cooling regulation if D.I. is active, otherwise heating reg.
<i>R.i. 0</i>	Analogue Input 0. Set AI to zero
<i>M. RES.</i>	Manual reset. Reset the outputs if selected as manual reset.
<i>t.1.RuN</i>	Timer 1 run. The timer 1 count with activated D.I.
<i>t.1. S.E.</i>	Timer 1 Start End. D.I. starts and stops the timer 1(impulsive)
<i>t.1.StR.</i>	Timer 1 Start. D.I. starts the timer 1(impulsive)
<i>t.1. ENd</i>	Timer 1 End. D.I. stops the timer 1(impulsive)
<i>t.2.RuN</i>	Timer 2 run. The timer 2 count with activated D.I.
<i>t.2. S.E.</i>	Timer 2 Start End. D.I. starts and stops the timer 2(impulsive)
<i>t.2.StR.</i>	Timer 2 Start. D.I. starts the timer 2(impulsive)
<i>t.2. ENd</i>	Timer 2 End. D.I. stops the timer 2(impulsive)
<i>Lo.cFG.</i>	Lock configuration and setpoints.
<i>uP.KEY</i>	Simulates the functioning of up key.
<i>dowN.K.</i>	Simulates the functioning of down key.
<i>Fnc. K.</i>	Simulates the functioning of fnc key.
<i>SEt. K.</i>	Simulates the functioning of set key.
<i>REM.S.E.</i>	Remote setpoint enabling. Enables Remote setpoint with activated D.I. Local setpoint with deactivated D.I. (remote setpoint must be enabled on parameter 56 <i>rEN.5.</i>)
<i>E.t.RL.</i>	External alarm. The controller goes on STOP and the alarms will be disabled. The controller does not return to START automatically: for this operation, the user's intervention is required.

248 *d.i.3.c.* Digital Input 3 Contact

Defines the resting contact of the digital input 3.

<i>N.oPEN</i>	Normally open (Default)
<i>N.cLoS.</i>	Normally closed

249 *d.i.3.P.* Digital Input 3 Process

Select the size related to the digital input 3.

<i>R.i.N.1</i>	Value read on input AI1. (Default)
<i>R.i.N.2</i>	Value read on input AI2.
<i>MERN</i>	Arithmetic average of the value read on inputs AI1 and AI2 $[(AI1-AI2)/2]$.
<i>d.FF.</i>	Difference of the values read on inputs AI1 and AI2 $(AI1-AI2)$.
<i>Rb.d.F.</i>	Module of the difference of the values read on inputs AI1 and AI2 $(AI1-AI2)$.
<i>Sum</i>	Sum of values read on inputs AI1 and AI2 $(AI1+AI2)$.

250 *d.i.3.r.* Digital Input 3 Reference Command

Defines the reference command for the digital input 3 functions.

<i>cMd. 1</i>	Command 1 (Default)
<i>cMd. 2</i>	Command 2
<i>cMd.1.2</i>	Command 1 and 2

251÷254 Reserved Parameters - Group O

Reserved parameters - Group O

GROUP P - *d. i. 4* - Digital input 4 (only on UR48483A/4A)

255 *d.i.4.F.* Digital Input 4 Function

Digital input 4 functioning.

<i>d.SRb.</i>	Disabled (Default)
<i>2E. SM.</i>	2 Setpoints Switch
<i>2E.SM.i.</i>	2 Setpoints Switch Impulsive
<i>3E.SM.i.</i>	3 Setpoints Switch Impulsive
<i>4E.SM.i.</i>	4 Setpoints Switch Impulsive
<i>SE./SE.</i>	Start / Stop
<i>RUN</i>	Run
<i>HoLd</i>	Lock conversion (stop all conversions and display values)
<i>tUNE</i>	Performing manual tune
<i>Ru.MR.i.</i>	Automatic / Manual Impulse (if enabled on parameter 48 or 67)
<i>Ru.MR.c.</i>	Automatic / Manual Contact (if enabled on parameter 48 or 67)
<i>RcE.tY.</i>	Action Type. Cooling regulation if D.I. is active, otherwise heating reg.
<i>R.i. 0</i>	Analogue Input 0. Set AI to zero
<i>M. RES.</i>	Manual reset. Reset the outputs if selected as manual reset.
<i>t.1.RuN</i>	Timer 1 run. The timer 1 count with activated D.I.
<i>t.1. S.E.</i>	Timer 1 Start End. D.I. starts and stops the timer 1(impulsive)
<i>t.1.StR.</i>	Timer 1 Start. D.I. starts the timer 1(impulsive)
<i>t.1. ENd</i>	Timer 1 End. D.I. stops the timer 1(impulsive)
<i>t.2.RuN</i>	Timer 2 run. The timer 2 count with activated D.I.
<i>t.2. S.E.</i>	Timer 2 Start End. D.I. starts and stops the timer 2(impulsive)
<i>t.2.StR.</i>	Timer 2 Start. D.I. starts the timer 2(impulsive)
<i>t.2. ENd</i>	Timer 2 End. D.I. stops the timer 2(impulsive)
<i>Lo.cFG.</i>	Lock configuration and setpoints.
<i>uP.KEY</i>	Simulates the functioning of up key.
<i>dowN.K.</i>	Simulates the functioning of down key.
<i>Fnc. K.</i>	Simulates the functioning of fnc key.
<i>SEt. K.</i>	Simulates the functioning of set key.
<i>REM.S.E.</i>	Remote setpoint enabling. Enables Remote setpoint with activated D.I. Local setpoint with deactivated D.I. (remote setpoint must be enabled on parameter 56 <i>rEN.5.</i>)
<i>E.t.RL.</i>	External alarm. The controller goes on STOP and the alarms will be disabled. The controller does not return to START automatically: for this operation, the user's intervention is required.

256 d.i.H.c. Digital Input 4 Contact

Defines the resting contact of the digital input 4.

N.oPEN Normally open (**Default**)

N.cLoS. Normally closed

257 d.i.H.P. Digital Input 4 Process

Select the size related to the digital input 4.

R.i.N.1 Value read on input AI1. (**Default**)

R.i.N.2 Value read on input AI2.

MERit Arithmetic average of the value read on inputs AI1 and AI2 $[(AI1-AI2)/2]$.

d.i.FF. Difference of the values read on inputs AI1 and AI2 $(AI1-AI2)$.

Rb.d.i.F. Module of the difference of the values read on inputs AI1 and AI2 $(|AI1-AI2|)$.

SuM Sum of values read on inputs AI1 and AI2 $(AI1+AI2)$.

258 d.i.H.c. Digital Input 4 Reference Command

Defines the reference command for the digital input 4 functions.

cMd. 1 Command 1 (**Default**)

cMd. 2 Command 2

cMd.1.2 Command 1 and 2

259÷262 Reserved Parameters - Group P

Reserved parameters - Group P

GROUP Q - 5FE5 - Soft-start and mini cycle**263 Pr.cY. Pre-programmed Cycle**

Enables special functionings.

d.iSRb. Disabled (**Default**)

ENRb. Enabled (all remote setpoint functions are inhibited)

264 5SEY. Soft-Start Type

Enables and selects the soft-start type

d.iSRb. Disabled (**Default**)

GRPd. Gradient

PERc. Percentage (only with pre-programmed cycle disabled)

265 5S.r.c. Soft-Start Reference Command (only on UR48483A/4A)

Defines the reference command for the Soft-Start and the pre-programmed cycle.

cMd. 1 Command 1 (**Default**)

cMd. 2 Command 2

cMd.1.2 Command 1 and 2

266 5SGr. Soft-Start Gradient

Rising/falling gradient for soft-start and pre-programmed cycle.

0..20000 Digit/ora (gradi.decimo/ora se temperatura). (**Default**: 100.0)

267 5SPE. Soft-Start Percentage

Output percentage during soft-start function.

0..100%. (**Default**: 50%)

268 5SEH. Soft-Start Threshold

Threshold under which the soft-start percentage function is activated, at starting.

-9999...30000 [digit^{1p.71}] (degrees.tenths for temp. sensors) (**Default**: 1000)

269 5SEt. Soft-Start Time

Max. Softstart duration: if the process will not reach the threshold selected on par. 5SEH. within the selected time, the controller starts to regulate on setpoint.

00:00 Disabled

00:01-24:00 hh:mm (**Default**: 00:15)

270 AR.t. Maintenance Time

Maintenance time for pre-programmed cycle.

00:00-24:00 hh.mm (**Default**: 00:00)

271 FRGr. Falling Gradient

Falling gradient for pre-programmed cycle.

0 Disabled (**Default**)

1..10000 Digit/ora^{1p.71} (degrees.tenths/hour if temperature)

272 dESE. Delayed Start

To set the initial waiting time for the delayed start of the setting or cycle, even in case of a blackout. The elapsed time is saved every 10 minutes.

0 Initial waiting time disabled: the controller starts immediately (**Default**)

00:01-24:00 hh.mm Initial waiting time enabled.

273÷276 Reserved Parameters - Group Q

Reserved parameters - Group Q

GROUP R - d.i.SP. - Display**277 uFLt Visualization Filter**

d.iSRb. Disabled

PEcHF Pitchfork filter (**Default**)

Fi.oRd. First Order

Fi.oR.P. First Order with Pitchfork

2.SR.M. 2 Samples Mean

...n Samples Mean

10.SR.M. 10 Samples Mean

278 u.i.d.2 Visualization Display 2

Selects visualization on display 2.

c.1.SPv Command 1 setpoint (**Default**)

ou.PE.1 Percentage of command output 1

R.i.N.1 Value read on input AI1.

R.i.N.2 Value read on input AI2.

MERit Arithmetic average of the value read on inputs AI1 and AI2 $[(AI1-AI2)/2]$.

d.i.FF. Difference of the values read on inputs AI1 and AI2 $(AI1-AI2)$.

Rb.d.i.F. Module of the difference of the values read on inputs AI1 and AI2 $(|AI1-AI2|)$.

SuM Sum of values read on inputs AI1 and AI2 $(AI1+AI2)$.

c.2.SPv Command 2 setpoint

ou.PE.2 Percentage of command output 2

AMPER. Ampere from current transformer

279 *Тпо.д.* **Timeout Display**

Determines the display timeout

<i>д.5Рб.</i>	Disabled. Display always ON (Default)
<i>15 5</i>	15 seconds
<i>1 М.М</i>	1 minute
<i>5 М.М</i>	5 minutes
<i>10М.М</i>	10 minutes
<i>30М.М</i>	30 minutes
<i>1 Н</i>	1 hour

280 *Тпо.5.* **Timeout Selection**

Selects which display is switched off when Display Timeout expires

<i>д.5Р.1</i>	Display 1
<i>д.5Р.2</i>	Display 2 (Default)
<i>д.5Р.1.2</i>	Display 1 and 2
<i>д.1.2.Лд.</i>	Display 1, 2 and led

281 *УПР.с.* **User Menu Pre-Programmed Cycle**

Allows to modify rising/falling gradient and retention time form the user menu, in pre-programmed cycle functioning. To access parameter modification, press **SET**.

<i>д.5Рб.</i>	Disabled (Default)
<i>Р.5.ГР.</i>	Only rising gradient
<i>МР.Е.т.</i>	Only retention time
<i>Р.Г.М.Е.</i>	Rising gradient and retention time
<i>ФРЛ.ГР.</i>	Only falling gradient
<i>Р.ФР.Г.</i>	Rising and falling gradient
<i>ФР.Г.М.Е.</i>	Falling gradient and retention time
<i>Р.Ф.Г.М.Е.</i>	Rising gradient, retention time and falling gradient

282 *У.ОУТ* **Voltage Output**

Selects the voltage on the sensors power terminals and of the digital outputs (SSR).

<i>12 V</i>	12 volt (Default)
<i>24 V</i>	24 volt

283 *5сЛ.т.* **Scrolling Time**

Select the duration for the visualization of the user menu data, before returning to the default page.

<i>3 5</i>	3 seconds
<i>5 5</i>	5 seconds (Default)
<i>10 5</i>	10 seconds
<i>30 5</i>	30 seconds
<i>1 М.М</i>	1 minutes
<i>5 М.М</i>	5 minutes
<i>10М.М</i>	10 minutes
<i>МРН.5с.</i>	Manual scroll

284 *д.5РФ.* **Display Special Functions**

<i>д.5Рб.</i>	Special functions disabled
<i>5МРР</i>	Shows the setpoint on display 1 and the process on display 2 (only if Par. 278 <i>У.и.д.2</i> set on <i>с.15Р.У</i>)

285 *нФс.Л.* **NFC Lock**

<i>д.5Рб.</i>	NFC lock disabled: NFC accessible.
<i>ЕМРб.</i>	NFC lock enabled: NFC not accessible.

286 *5.5.5.Ф.* **Set Key Special Functions**

Assign special functions to the **SET** button. To execute the function the button must be pressed for 1 second. The selections *2т.5М.т.*, *3т.5М.т.*, *4т.5М.т.* and *Р.и.т.* are not available for versions with double analogue input (UR48483A and UR48484A).

<i>д.5Рб.</i>	No special function linked to the SET key. (Default)
<i>5т./5т.</i>	Start/Stop. Pressing SET key the controller switches from Start to Stop and viceversa. Status of the controller, upon power-up, depends on parameter ini.s.
<i>2т.5М.т.</i>	2 Threshold Command Setpoint Switch. The controller changes the regulation setpoint alternating between Set1 and Set2
<i>3т.5М.т.</i>	3 Threshold Command Setpoint Switch. The controller changes the regulation setpoint alternating between Set1, Set2 and Set3
<i>4т.5М.т.</i>	4 Threshold Command Setpoint Switch. The controller changes the regulation setpoint alternating between Set1, Set2, Set3 and Set4
<i>Р.и.т.</i>	Analogue Input 0. Set analogue input to zero (zero tare)

GROUP S - *ст* - **Current transformer** (only on UR48483A/4A/5A)

287 *сст.Ф.* **Current Transformer Function**

Enables the C.T. input and selects the net frequency

<i>д.5Рб.</i>	Disabilitato (Default)
<i>50 HZ</i>	50 Hz
<i>60 HZ</i>	60 Hz

288 *сст.У.* **Current Transformer Value**

Selects the amperometric transformer full-scale

<i>1..200</i>	Ampere (Default: 50)
---------------	-----------------------------

289 *Н.б.Р.с.* **Heater Break Alarm Reference Command**

Defines the reference command for the heater break alarm and the overcurrent alarm.

<i>сМд. 1</i>	Command 1 (Default)
<i>сМд. 2</i>	Command 2

290 *Н.б.Р.т.* **Heater Break Alarm Threshold**

Heater Break Alarm activation threshold

<i>0</i>	Alarm disabled. (Default:)
<i>0.1-200.0</i>	Ampere.

291 *о.с.У.т.* **Overcurrent Alarm Threshold**

Overcurrent alarm threshold.

<i>0</i>	Alarm disabled. (Default)
<i>0.1-200.0</i>	Ampere

292 *Н.б.Р.д.* **Heater Break Alarm Delay**

Heater Break Alarm and overcurrent alarm activation delay.

<i>00:00-60:00</i>	mm:ss (Default: 01:00)
--------------------	-------------------------------

293÷297 **Reserved Parameters - Group S**

Reserved parameters - Group S

GROUP T - *P. 1* - Retransmission 1

298 *r1.1* Retransmission 1

Retransmission for output. Parameters 300 and 301 define lower and upper limit of the operating scale.

<i>d1.5Ab.</i>	Disabled (Default)
<i>c.1.5Pv</i>	Command 1 setpoint
<i>AL. 1</i>	Alarm 1 setpoint
<i>AL. 2</i>	Alarm 2 setpoint
<i>Id.bu5</i>	Retransmits the value written on word 1241
<i>R.in.1</i>	Value read on input AI1
<i>R.in.2</i>	Value read on input AI2
<i>MERH</i>	Arithmetic average of the value read on inputs AI1 and AI2 $[(AI1+AI2)/2]$
<i>d1.FF.</i>	Difference of the values read on inputs AI1 and AI2 $(AI1-AI2)$
<i>Ab.d1.F.</i>	Module of the difference of the values read on inputs AI1 and AI2 $(AI1-AI2)$
<i>Sum</i>	Sum of values read on inputs AI1 and AI2 $(AI1+AI2)$
<i>c.2.5Pv</i>	Command 2 setpoint
<i>AMPER.</i>	Ampere from current transformer

299 *r1.ty.* Retransmission 1 Type

Selects the retransmission type for AO1

<i>0.10 V</i>	Output 0...10 V.
<i>4.20mA</i>	Output 4...20 mA. Default

300 *r1.LL.* Retransmission 1 Lower Limit

Retransmission 1 lower limit range (value related to 10 V or 0/4 mA).
-9999..+30000 [digit^{1 p.71}] (degrees if temperature), **Default**: 0.

301 *r1.uL.* Retransmission 1 Upper Limit

Retransmission 1 upper limit range 2 (value related to 10 V or 20 mA).
-9999..+30000 [digit^{1 p.71}] (degrees if temperature), **Default**: 1000.

302 *r1.5.E.* Retransmission 1 State Error

Determines retransmission 1 value in case of error or anomaly

If the retransmission output is 0-10V:

<i>0 V</i>	0 V. Default
<i>10 V</i>	10 V.

If the retransmission output is 0-20 mA or 4-20 mA:

<i>0 mA</i>	0 mA. Default
<i>4 mA</i>	4 mA.
<i>20 mA</i>	20 mA.
<i>21.5mA</i>	21.5 mA.

303÷307 Reserved Parameters - Group T

Reserved parameters - Group T

GROUP U - *P. 2* - Retransmission 2 (only on UR48483A/4A)

308 *r2.2* Retransmission 2

Retransmission for output AO2. Parameters 310 and 311 define lower and upper limit of the operating scale.

<i>d1.5Ab.</i>	Disabled (Default)
<i>c.1.5Pv</i>	Command 1 setpoint
<i>AL. 1</i>	Alarm 1 setpoint
<i>AL. 2</i>	Alarm 2 setpoint
<i>Id.bu5</i>	Retransmits the value written on word 1242
<i>R.in.1</i>	Value read on input AI1
<i>R.in.2</i>	Value read on input AI2
<i>MERH</i>	Arithmetic average of the value read on inputs AI1 and AI2 $[(AI1+AI2)/2]$
<i>d1.FF.</i>	Difference of the values read on inputs AI1 and AI2 $(AI1-AI2)$
<i>Ab.d1.F.</i>	Module of the difference of the values read on inputs AI1 and AI2 $(AI1-AI2)$
<i>Sum</i>	Sum of values read on inputs AI1 and AI2 $(AI1+AI2)$
<i>c.2.5Pv</i>	Command 2 setpoint
<i>AMPER.</i>	Ampere from current transformer

309 *r2.ty.* Retransmission 2 Type

Selects the retransmission type for AO2

<i>0.10 V</i>	Output 0...10 V.
<i>4.20mA</i>	Output 4...20 mA. Default

310 *r2.LL.* Retransmission 2 Lower Limit

Retransmission 2 lower limit range (value related to 10 V or 0/4 mA).
-9999..+30000 [digit^{1 p.71}] (degrees if temperature), **Default**: 0.

311 *r2.uL.* Retransmission 2 Upper Limit

Retransmission 2 upper limit range 2 (value related to 10 V or 20 mA).
-9999..+30000 [digit^{1 p.71}] (degrees if temperature), **Default**: 1000.

312 *r2.5.E.* Retransmission 2 State Error

Determines retransmission 2 value in case of error or anomaly.

If the retransmission output is 0-10V:

<i>0 V</i>	0 V. Default
<i>10 V</i>	10 V.

If the retransmission output is 0-20 mA or 4-20 mA:

<i>0 mA</i>	0 mA. Default
<i>4 mA</i>	4 mA.
<i>20 mA</i>	20 mA.
<i>21.5mA</i>	21.5 mA.

313÷317 Reserved Parameters - Group U

Reserved parameters - Group U

GROUP V - *5Er* - Serial (not available on UR48481A/5A)

318 *5LAd*. **Slave Address**

Selects slave address for serial communication.
1...254. **Default:** 247.

319 *bd.r.t.* **Baud Rate**

Selects baudrate for serial communication

<i>1.2 K</i>	1200 bit/s
<i>2.4 K</i>	2400 bit/s
<i>4.8 K</i>	4800 bit/s
<i>9.6 K</i>	9600 bit/s
<i>19.2 K</i>	19200 bit/s (Default)
<i>28.8 K</i>	28800 bit/s
<i>38.4 K</i>	38400 bit/s
<i>57.6 K</i>	57600 bit/s
<i>115.2K</i>	115200 bit/s

320 *5.P.P.* **Serial Port Parameters**

Selects the format for the modbus RTU serial communication.

<i>B-N-1</i>	8 bit, no parity, 1 stop bit (Default)
<i>B-E-1</i>	8 bit, even parity, 1 stop bit
<i>B-o-1</i>	8 bit, odd parity, 1 stop bit
<i>B-N-2</i>	8 bit, no parity, 2 stop bit
<i>B-E-2</i>	8 bit, even parity, 2 stop bit
<i>B-o-2</i>	8 bit, odd parity, 2 stop bit

321 *5E.dE.* **Serial Delay**

Selects serial delay
0...100 ms. **Default:** 5 ms.

322 *oFFL.* **Off Line**

Selects the off-line time. If there is no serial communication during the selected time, the controller switches-off the command output.
0 Offline disabled (**Default**)
0.1-600.0 tenths of second.

323÷327 **Reserved Parameters - Group V**

Reserved parameters - Group V

GROUP W - *Er* - Timer

328 *Er.1* **Timer 1**

Enabling Timer 1
d.5Rb. Disabled (**Default**)
ENRb. Enabled
EN.5Er. Enabled and active at start

329 *E.b.E.1* **Time Base Timer 1**

Selects time base for timer 1
MM.SS minutes.seconds (**Default**)
HH.MM hours.minutes

330 *A.E.N.1* **Action Timer 1**

Select the type of the action executed by the timer 1 to be related to an alarm..
5tARPt Start. Active during timer counting (**Default**)
ENd End. Active at timer expiry
WARRN. Warning. Active 5" before the timer expiry

331 *Er.2* **Timer 2**

Enabling Timer 2
d.5Rb. Disabled (**Default**)
ENRb. Enabled
EN.5Er. Enabled and active at start

332 *E.b.E.2* **Time Base Timer 2**

Selects time base for timer 2
MM.SS minutes.seconds (**Default**)
HH.MM hours.minutes

333 *A.E.N.2* **Action Timer 2**

Select the type of the action executed by the timer 2 to be related to an alarm..
5tARPt Start. Active during timer counting (**Default**)
ENd End. Active at timer expiry.
WARRN. Warning. Active 5" before the timer expiry.

334 *Er.S.* **Timers Sequence**

Select the correlation between the two timers.
SiNGL. Singles. Timers work independently (**Default**)
SEQuE. Sequential. When timer 1 ends, timer 2 starts.
LooP Loop. When a timer ends, another starts.

335÷339 **Reserved Parameters - Group W**

Reserved parameters - Group W

14 Alarm Intervention Modes

14.a Absolute or threshold alarm active over (par. 123 $R.L.I.F. = Ab.u.PA$)

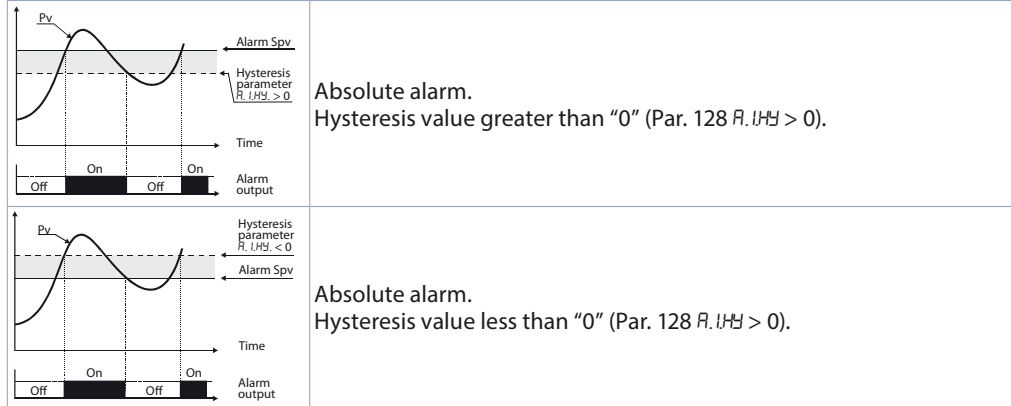

14.b Absolute or threshold alarm referred to command setpoint active over (par. 123 $R.L.I.F. = Ab.c.u.A$)

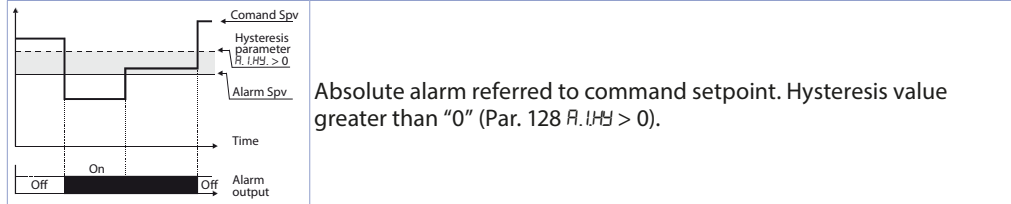

14.c Band alarm (par. 123 $R.L.I.F. = bAnd$)

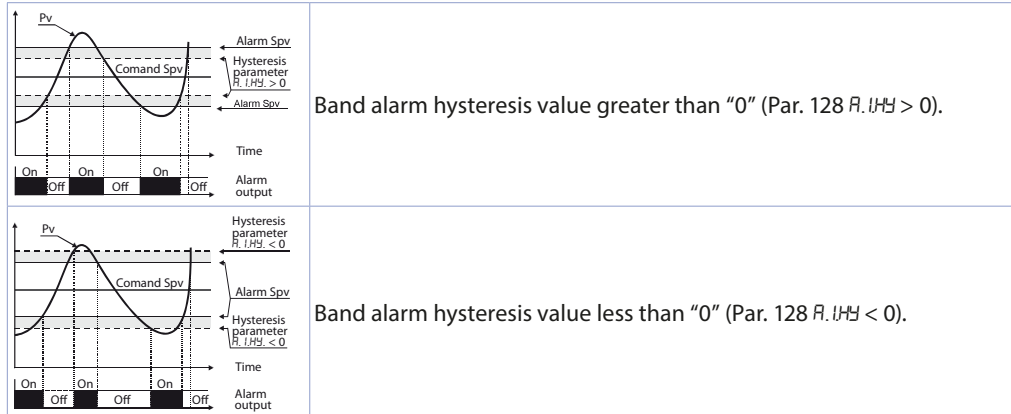

14.d Upper deviation alarm (par. 123 $R.L.I.F. = uP.dEu$)

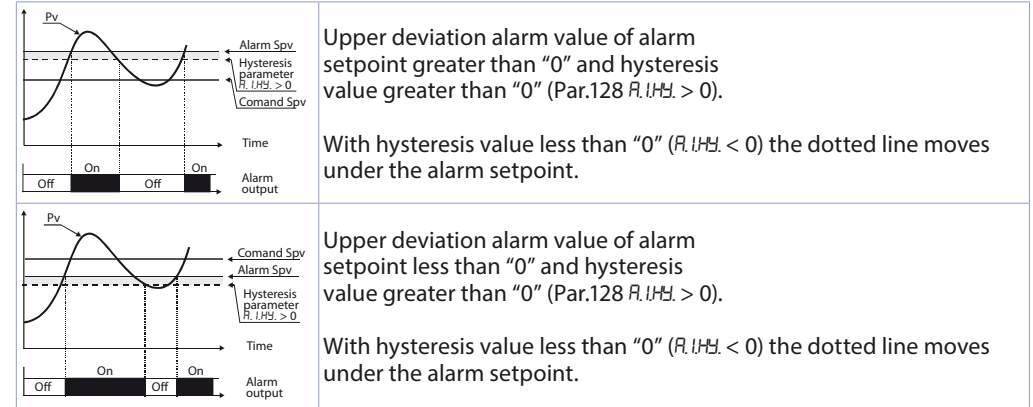

14.e Lower deviation alarm (par. 123 $R.L.I.F. = Lo.dEu$)

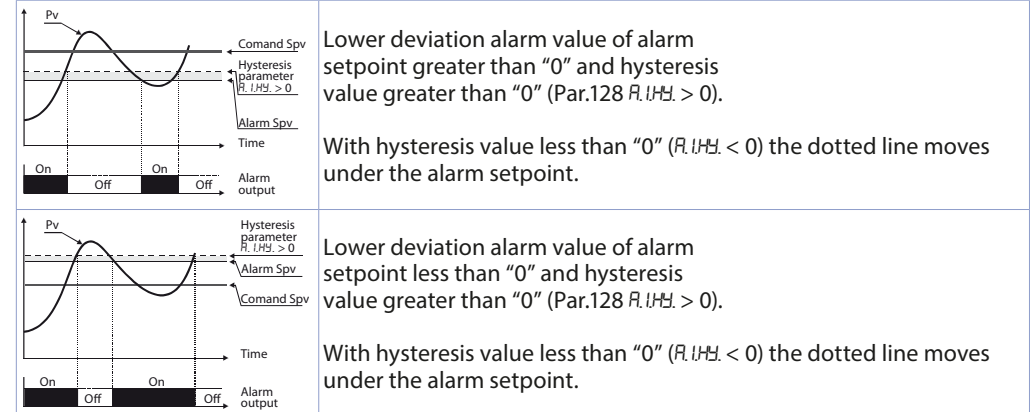

14.1 Alarms label

By setting a value from 1 to 20 on the parameters 136 A.1.Lb., 154 A.2.Lb., 172 A.3.Lb., 190 A.4.Lb., 208 A.5.Lb. e 226 A.6.Lb., the display 2 will show one of the following messages in case of alarm:

Selection	Message displayed in the alarm event
1	alarm 1
2	alarm 2
3	alarm 3
4	alarm 4
5	alarm 5
6	alarm 6
7	open door
8	closed door
9	light on
10	light off
11	warning
12	waiting
13	high limit
14	low limit
15	external alarm
16	temperature alarm
17	pressure alarm
18	fan command
19	cooling
20	operating

By setting 0, no message will be displayed. While setting 21, the user will have up to 23 characters available to customize his message via the "Wachendorff EMG" App or via modbus.

15 Table of Anomaly Signals

If installation malfunctions, the controller switches off the regulation output and reports the anomaly noticed. For example, controller will report failure of a connected thermocouple visualizing E-05 (flashing) flashing on display.

For other signals see table below.

	Cause	What to do
E-02 SYSTEM Error	Cold junction temperature sensor failure or environment temperature out of range	Call assistance
E-04 EEPROM Error	Incorrect configuration data. Possible loss of instrument calibration	Verify that configuration parameters are correct.
E-05 Probe 1 Error	Sensor connected to AI1 broken or temperature out of range	Control connection with probes and their integrity.
E-06 Probe 2 Error	Sensor connected to AI2 broken or temperature out of range	Control connection with probes and their integrity.
E-08 SYSTEM Error	Missing calibration	Call assistance
E-10 Analog Disabled	Analogue input 2 disabled but used during configuration.	Enable <i>An2</i> or disable it during configuration.
E-80 RFID Error	Tag rfid malfunctioning	Call assistance

Notes / Updates

- 1 Display of decimal point depends on setting of parameter *SEn*. and parameter *d.P*.
- 2 On activation, the output is inhibited if the controller is in alarm mode. Activates only if alarm condition reappears, after that it was restored.

Table of configuration parameters

GROUP A - <i>AI</i> - Analogue input 1		
1	<i>Sen.1</i>	Sensor AI1 30
2	<i>d.P. 1</i>	Decimal Point 1 30
3	<i>dEGr.</i>	Degree 30
4	<i>LL.i.1</i>	Lower Linear Input AI1 30
5	<i>UL.i.1</i>	Upper Linear Input AI1 30
6	<i>P.vA.1</i>	Potentiometer Value AI1 30
7	<i>l.o.L.1</i>	Linear Input over Limits AI1 31
8	<i>o.cA.1</i>	Offset Calibration AI1 31
9	<i>G.cA.1</i>	Gain Calibration AI1 31
10	<i>Lt.c.1</i>	Latch-On AI1 31
11	<i>c.FL.1</i>	Conversion Filter AI1 31
12	<i>c.Fr.1</i>	Conversion Frequency AI1 31
13÷17		Reserved Parameters - Group A 31
GROUP B - <i>AI</i> - Analogue input 2 (only on UR48483A/4A)		
18	<i>Sen.2</i>	Sensor AI2 32
19	<i>d.P. 2</i>	Decimal Point 2 32
20	<i>rES.</i>	Reserved 32
21	<i>LL.i.2</i>	Lower Linear Input AI2 32
22	<i>UL.i.2</i>	Upper Linear Input AI2 32
23	<i>P.vA.2</i>	Potentiometer Value AI2 32
24	<i>l.o.L.2</i>	Linear Input over Limits AI2 33
25	<i>o.cA.2</i>	Offset Calibration AI2 33
26	<i>G.cA.2</i>	Gain Calibration AI2 33
27	<i>Lt.c.2</i>	Latch-On AI2 33
28	<i>c.FL.2</i>	Conversion Filter AI2 33
29	<i>c.Fr.2</i>	Conversion Frequency AI2 33
30÷34		Reserved Parameters - Group B 33
GROUP C - <i>CO</i> - Outputs and regulation Process 1		
35	<i>c.ov.1</i>	Command Output 1 34
36	<i>c.Pr.1</i>	Command Process 1 (only on UR48483A/4A) 34
37	<i>rES.</i>	Reserved 34
38	<i>Ac.t.1</i>	Action type 1 35
39	<i>c.Hy.1</i>	Command Hysteresis 1 35
40	<i>LLS.1</i>	Lower Limit Setpoint 1 35
41	<i>ULS.1</i>	Upper Limit Setpoint 1 35
42	<i>c.rE.1</i>	Command Reset 1 35
43	<i>c.S.E.1</i>	Command State Error 1 35
44	<i>c.Ld.1</i>	Command Led 1 35
45	<i>c.dE.1</i>	Command Delay 1 35
46	<i>c.S.P.1</i>	Command Setpoint Protection 1 36
47	<i>vA.t.1</i>	Valve Time 1 36
48	<i>A.M.A.1</i>	Automatic / Manual 1 36
49	<i>in.S.</i>	Initial State 36
50÷53		Reserved Parameters - Group C 36
GROUP D - <i>CO</i> - Outputs and regul. Process 2 (only on UR48483A/4A)		
54	<i>c.ov.2</i>	Command Output 2 36

55	<i>c.Pr.2</i>	Command Process 2 36
56	<i>rES.</i>	Remote Setpoint 37
57	<i>Ac.t.2</i>	Action type 2 37
58	<i>c.Hy.2</i>	Command Hysteresis 2 37
59	<i>LLS.2</i>	Lower Limit Setpoint 2 37
60	<i>ULS.2</i>	Upper Limit Setpoint 2 37
61	<i>c.rE.2</i>	Command Reset 2 37
62	<i>c.S.E.2</i>	Command State Error 2 37
63	<i>c.Ld.2</i>	Command Led 2 38
64	<i>c.dE.2</i>	Command Delay 2 38
65	<i>c.S.P.2</i>	Command Setpoint Protection 2 38
66	<i>vA.t.2</i>	Valve Time 2 38
67	<i>A.M.A.2</i>	Automatic / Manual 2 38
68÷72		Reserved Parameters - Group D 38
GROUP E - <i>CT</i> - Autotuning and PID 1		
73	<i>tun.1</i>	Tune 1 38
74	<i>S.d.t.1</i>	Setpoint Deviation Tune 1 38
75	<i>P.b. 1</i>	Proportional Band 1 38
76	<i>i.t. 1</i>	Integral Time 1 39
77	<i>d.t. 1</i>	Derivative Time 1 39
78	<i>d.b. 1</i>	Dead Band 1 39
79	<i>P.b.c.1</i>	Proportional Band Centered 1 39
80	<i>o.o.S.1</i>	Off Over Setpoint 1 39
81	<i>o.d.t.1</i>	Off Deviation Threshold 1 39
82	<i>c.t. 1</i>	Cycle Time 1 39
83	<i>co.F.1</i>	Cooling Fluid 1 39
84	<i>P.b.M.1</i>	Proportional Band Multiplier 1 39
85	<i>o.d.b.1</i>	Overlap / Dead Band 1 39
86	<i>c.c.t.1</i>	Cooling Cycle Time 1 39
87	<i>LL.P.1</i>	Lower Limit Output Percentage 1 40
88	<i>UL.P.1</i>	Upper Limit Output Percentage 1 40
89	<i>MG.t.1</i>	Max Gap Tune 1 40
90	<i>Min.P.1</i>	Minimum Proportional Band 1 40
91	<i>Max.P.1</i>	Maximum Proportional Band 1 40
92	<i>Min.i.1</i>	Minimum Integral Time 1 40
93	<i>o.c.L.1</i>	Overshoot Control Level 1 40
94÷97		Reserved Parameters - Group E 40
GROUP F - <i>CT</i> - Autotuning and PID 2 (only on UR48483A/4A)		
98	<i>tun.2</i>	Tune 2 40
99	<i>S.d.t.2</i>	Setpoint Deviation Tune 2 40
100	<i>P.b. 2</i>	Proportional Band 2 41
101	<i>i.t. 2</i>	Integral Time 2 41
102	<i>d.t. 2</i>	Derivative Time 2 41
103	<i>d.b. 2</i>	Dead Band 2 41
104	<i>P.b.c.2</i>	Proportional Band Centered 2 41
105	<i>o.o.S.2</i>	Off Over Setpoint 2 41
106	<i>o.d.t.2</i>	Off Deviation Threshold 2 41
107	<i>c.t. 2</i>	Cycle Time 2 41
108	<i>co.F.2</i>	Cooling Fluid 2 41

109	<i>P.b.P2</i>	Proportional Band Multiplier 2	41
110	<i>o.d.b.2</i>	Overlap / Dead Band 2	42
111	<i>c.c.t.2</i>	Cooling Cycle Time 2	42
112	<i>L.L.P2</i>	Lower Limit Output Percentage 2	42
113	<i>u.L.P2</i>	Upper Limit Output Percentage 2	42
114	<i>M.G.t.2</i>	Max Gap Tune 2	42
115	<i>m.p.2</i>	Minimum Proportional Band 2	42
116	<i>M.P.2</i>	Maximum Proportional Band 2	42
117	<i>m.i.2</i>	Minimum Integral Time 2	42
118	<i>o.c.L.2</i>	Overshoot Control Level 2	42
119÷122		Reserved Parameters - Group F	42

GROUP G - *AL. 1* - ALARM 1

123	<i>AL.1.F.</i>	Alarm 1 Function	43
124	<i>AL.1.Pr.</i>	Alarm 1 Process (only on UR48483A/4A)	43
125	<i>AL.1.r.c.</i>	Alarm 1 Reference Command (only on UR48483A/4A)	43
126	<i>AL.1.s.o.</i>	Alarm 1 State Output	43
127	<i>rES.</i>	Reserved	43
128	<i>AL.1.HY.</i>	Alarm 1 Hysteresis	44
129	<i>AL.1.LL.</i>	Alarm 1 Lower Limit	44
130	<i>AL.1.u.L.</i>	Alarm 1 Upper Limit	44
131	<i>AL.1.rE.</i>	Alarm 1 Reset	44
132	<i>AL.1.S.E.</i>	Alarm 1 State Error	44
133	<i>AL.1.Ld.</i>	Alarm 1 Led	44
134	<i>AL.1.dE.</i>	Alarm 1 Delay	44
135	<i>AL.1.S.P.</i>	Alarm 1 Setpoint Protection	44
136	<i>AL.1.Lb.</i>	Alarm 1 Label	44
137÷140		Reserved Parameters - Group G	44

GRUPPO H - *AL. 2* - Alarm 2

141	<i>AL.2.F.</i>	Alarm 2 Function	45
142	<i>AL.2.Pr.</i>	Alarm 2 Process (only on UR48483A/4A)	45
143	<i>AL.2.r.c.</i>	Alarm 2 Reference Command (only on UR48483A/4A)	45
144	<i>AL.2.s.o.</i>	Alarm 2 State Output	45
145	<i>rES.</i>	Reserved	45
146	<i>AL.2.HY.</i>	Alarm 2 Hysteresis	46
147	<i>AL.2.LL.</i>	Alarm 2 Lower Limit	46
148	<i>AL.2.u.L.</i>	Alarm 2 Upper Limit	46
149	<i>AL.2.rE.</i>	Alarm 2 Reset	46
150	<i>AL.2.S.E.</i>	Alarm 2 State Error	46
151	<i>AL.2.Ld.</i>	Alarm 2 Led	46
152	<i>AL.2.dE.</i>	Alarm 2 Delay	46
153	<i>AL.2.S.P.</i>	Alarm 2 Setpoint Protection	46
154	<i>AL.2.Lb.</i>	Alarm 2 Label	46
155÷158		Reserved Parameters - Group H	46

GROUP I - *AL. 3* - Alarm 3

159	<i>AL.3.F.</i>	Alarm 3 Function	47
160	<i>AL.3.Pr.</i>	Alarm 3 Process (only on UR48483A/4A)	47
161	<i>AL.3.r.c.</i>	Alarm 3 Reference Command (only on UR48483A/4A)	47
162	<i>AL.3.s.o.</i>	Alarm 3 State Output	47
163	<i>AL.3.o.t.</i>	Alarm 3 Output Type	48

164	<i>AL.3.HY.</i>	Alarm 3 Hysteresis	48
165	<i>AL.3.LL.</i>	Alarm 3 Lower Limit	48
166	<i>AL.3.u.L.</i>	Alarm 3 Upper Limit	48
167	<i>AL.3.rE.</i>	Alarm 3 Reset	48
168	<i>AL.3.S.E.</i>	Alarm 3 State Error	48
169	<i>AL.3.Ld.</i>	Alarm 3 Led	48
170	<i>AL.3.dE.</i>	Alarm 3 Delay	48
171	<i>AL.3.S.P.</i>	Alarm 3 Setpoint Protection	48
172	<i>AL.3.Lb.</i>	Alarm 3 Label	49
173÷176		Reserved Parameters - Group I	49

GROUP J - *AL. 4* - Alarm 4

177	<i>AL.4.F.</i>	Alarm 4 Function	49
178	<i>AL.4.Pr.</i>	Alarm 4 Process (only on UR48483A/4A)	49
179	<i>AL.4.r.c.</i>	Alarm 4 Reference Command	50
180	<i>AL.4.s.o.</i>	Alarm 4 State Output	50
181	<i>AL.4.o.t.</i>	Alarm 4 Output Type	50
182	<i>AL.4.HY.</i>	Alarm 4 Hysteresis	50
183	<i>AL.4.LL.</i>	Alarm 4 Lower Limit	50
184	<i>AL.4.u.L.</i>	Alarm 4 Upper Limit	50
185	<i>AL.4.rE.</i>	Alarm 4 Reset	50
186	<i>AL.4.S.E.</i>	Alarm 4 State Error	50
187	<i>rES.</i>	Reserved	50
188	<i>AL.4.dE.</i>	Alarm 4 Delay	51
189	<i>AL.4.S.P.</i>	Alarm 4 Setpoint Protection	51
190	<i>AL.4.Lb.</i>	Alarm 4 Label	51
191÷194		Reserved Parameters - Group J	51

GROUP K - *AL. 5* - Alarm 5 (only on UR48483A/4A/5A)

195	<i>AL.5.F.</i>	Alarm 5 Function	51
196	<i>AL.5.Pr.</i>	Alarm 5 Process (only on UR48483A/4A)	52
197	<i>AL.5.r.c.</i>	Alarm 5 Reference Command (only on UR48483A/4A)	52
198	<i>AL.5.s.o.</i>	Alarm 5 State Output	52
199	<i>AL.5.o.t.</i>	Alarm 5 Output Type	52
200	<i>AL.5.HY.</i>	Alarm 5 Hysteresis	52
201	<i>AL.5.LL.</i>	Alarm 5 Lower Limit	52
202	<i>AL.5.u.L.</i>	Alarm 5 Upper Limit	52
203	<i>AL.5.rE.</i>	Alarm 5 Reset	52
204	<i>AL.5.S.E.</i>	Alarm 5 State Error	53
205	<i>rES.</i>	Reserved	53
206	<i>AL.5.dE.</i>	Alarm 5 Delay	53
207	<i>AL.5.S.P.</i>	Alarm 5 Setpoint Protection	53
208	<i>AL.5.Lb.</i>	Alarm 5 Label	53
209÷212		Reserved Parameters - Group K	53

GROUP L - *AL. 6* - Alarm 6 (only on UR48483A/4A)

213	<i>AL.6.F.</i>	Alarm 6 Function	54
214	<i>AL.6.Pr.</i>	Alarm 6 Process	54
215	<i>AL.6.r.c.</i>	Alarm 6 Reference Command	54
216	<i>AL.6.s.o.</i>	Alarm 6 State Output	54
217	<i>AL.6.o.t.</i>	Alarm 6 Output Type	55
218	<i>AL.6.HY.</i>	Alarm 6 Hysteresis	55

219	<i>AL.L</i>	Alarm 6 Lower Limit	55
220	<i>AL.U.L</i>	Alarm 6 Upper Limit	55
221	<i>AL.R.E</i>	Alarm 6 Reset	55
222	<i>AL.S.E</i>	Alarm 6 State Error	55
223	<i>RES</i>	Reserved	55
224	<i>AL.D.E</i>	Alarm 6 Delay	55
225	<i>AL.S.P</i>	Alarm 6 Setpoint Protection	55
226	<i>AL.Lb</i>	Alarm 6 Label	55
227÷230		Reserved Parameters - Group L	56
GROUP M - <i>d.i. 1</i> - Digital input 1			
231	<i>d.i.1.F</i>	Digital Input 1 Function	56
232	<i>d.i.1.c</i>	Digital Input 1 Contact	56
233	<i>d.i.1.P</i>	Digital Input 1 Process (only on UR48483A/4A)	56
234	<i>d.i.1.r</i>	Digital Input 1 Reference Command	57
235÷238		Reserved Parameters - Group M	57
GROUP N - <i>d.i. 2</i> - Digital input 2			
239	<i>d.i.2.F</i>	Digital Input 2 Function	57
240	<i>d.i.2.c</i>	Digital Input 2 Contact	57
241	<i>d.i.2.P</i>	Digital Input 2 Process (only on UR48483A/4A)	57
242	<i>d.i.2.r</i>	Digital Input 2 Reference Command	58
243÷246		Reserved Parameters - Group N	58
GROUP O - <i>d.i. 3</i> - Digital input 3 (only on UR48483A/4A)			
247	<i>d.i.3.F</i>	Digital Input 3 Function	58
248	<i>d.i.3.c</i>	Digital Input 3 Contact	58
249	<i>d.i.3.P</i>	Digital Input 3 Process	59
250	<i>d.i.3.r</i>	Digital Input 3 Reference Command	59
251÷254		Reserved Parameters - Group O	59
GROUP P - <i>d.i. 4</i> - Digital input 4 (only on UR48483A/4A)			
255	<i>d.i.4.F</i>	Digital Input 4 Function	59
256	<i>d.i.4.c</i>	Digital Input 4 Contact	60
257	<i>d.i.4.P</i>	Digital Input 4 Process	60
258	<i>d.i.4.r</i>	Digital Input 4 Reference Command	60
259÷262		Reserved Parameters - Group P	60
GROUP Q - <i>SS.F.L.S</i> - Soft-start and mini cycle			
263	<i>Pr.cy</i>	Pre-programmed Cycle	60
264	<i>SS.ty</i>	Soft-Start Type	60
265	<i>SS.r.c</i>	Soft-Start Reference Command (only on UR48483A/4A)	60
266	<i>SS.Gr</i>	Soft-Start Gradient	60
267	<i>SS.PE</i>	Soft-Start Percentage	60
268	<i>SS.tH</i>	Soft-Start Threshold	60
269	<i>SS.ti</i>	Soft-Start Time	61
270	<i>MA.ti</i>	Maintenance Time	61
271	<i>FR.Gr</i>	Falling Gradient	61
272	<i>dE.St</i>	Delayed Start	61
273÷276		Reserved Parameters - Group Q	61
GROUP R - <i>d.SP</i> - Display			
277	<i>v.Fl.t</i>	Visualization Filter	61
278	<i>v.i.d.2</i>	Visualization Display 2	61

279	<i>tNo.d</i>	Timeout Display	62
280	<i>tNo.S</i>	Timeout Selection	62
281	<i>u.M.P.c</i>	User Menu Pre-Programmed Cycle	62
282	<i>v.out</i>	Voltage Output	62
283	<i>ScL.t</i>	Scrolling Time	62
284	<i>dSPF</i>	Display Special Functions	62
285	<i>nFcL</i>	NFC Lock	62
286	<i>S.F.S.F</i>	Set Key Special Functions	63
GROUP S - <i>ct</i> - Current transformer (only on UR48483A/4A/5A)			
287	<i>ct.F</i>	Current Transformer Function	63
288	<i>ct.v</i>	Current Transformer Value	63
289	<i>H.b.A.r</i>	Heater Break Alarm Reference Command	63
290	<i>H.b.A.t</i>	Heater Break Alarm Threshold	63
291	<i>oc.t</i>	Overcurrent Alarm Threshold	63
292	<i>H.b.A.d</i>	Heater Break Alarm Delay	63
293÷297		Reserved Parameters - Group S	63
GROUP T - <i>RA. 1</i> - Retransmission 1			
298	<i>reN.1</i>	Retransmission 1	64
299	<i>re.ty</i>	Retransmission 1 Type	64
300	<i>re.L.L</i>	Retransmission 1 Lower Limit	64
301	<i>re.U.L</i>	Retransmission 1 Upper Limit	64
302	<i>re.S.E</i>	Retransmission 1 State Error	64
303÷307		Reserved Parameters - Group T	64
GROUP U - <i>RA. 2</i> - Retransmission 2 (only on UR48483A/4A)			
308	<i>reN.2</i>	Retransmission 2	65
309	<i>re.ty</i>	Retransmission 2 Type	65
310	<i>re.L.L</i>	Retransmission 2 Lower Limit	65
311	<i>re.U.L</i>	Retransmission 2 Upper Limit	65
312	<i>re.S.E</i>	Retransmission 2 State Error	65
313÷317		Reserved Parameters - Group U	65
GROUP V - <i>SEr</i> - Seriale (not available on UR48481A/5A)			
318	<i>Sl.Ad</i>	Slave Address	66
319	<i>bd.r.t</i>	Baud Rate	66
320	<i>S.P.P</i>	Serial Port Parameters	66
321	<i>SE.dE</i>	Serial Delay	66
322	<i>oFF.L</i>	Off Line	66
323÷327		Reserved Parameters - Group V	66
GROUP W - <i>t.Nr</i> - Timer			
328	<i>tNr.1</i>	Timer 1	67
329	<i>t.b.t.1</i>	Time Base Timer 1	67
330	<i>A.tNr.1</i>	Action Timer 1	67
331	<i>tNr.2</i>	Timer 2	67
332	<i>t.b.t.2</i>	Time Base Timer 2	67
333	<i>A.tNr.2</i>	Action Timer 2	67
334	<i>tNr.S</i>	Timers Sequence	67
335÷339		Reserved Parameters - Group W	67



RoHS 
Compliant



WACHENDORFF

Prozesstechnik GmbH & Co. KG

Wachendorff Prozesstechnik GmbH & Co. KG
Industriestrasse 7 • 65366 Geisenheim

Tel.: +49 (0) 67 22 / 99 65 - 20

Fax: +49 (0) 67 22 / 99 65 - 78

E-Mail: wp@wachendorff.de

www.wachendorff-prozesstechnik.de

© Copyright by Wachendorff Prozesstechnik GmbH & Co. KG